

# International Conference on Space Optics—ICSO 2022

Dubrovnik, Croatia

3–7 October 2022

*Edited by Kyriaki Minoglou, Nikos Karafolas, and Bruno Cugny,*



## ***NEW DEVELOPMENTS OF MULTILINEAR AND MULTISPECTRAL INFRARED SENSORS FOR SPACE APPLICATIONS AT LYNRED***



# NEW DEVELOPMENTS OF MULTILINEAR AND MULTISPECTRAL INFRARED SENSORS FOR SPACE APPLICATIONS AT LYNRED

N. Jamin (author)<sup>1</sup>, F. Salvetti<sup>1</sup>, L. Baud<sup>1</sup>, J. Berthoz<sup>1</sup>, L. Martineau<sup>1</sup>, V. Bourrillon<sup>1</sup>, P. Lopez<sup>1</sup>, P. Chorier<sup>1</sup>

<sup>(1)</sup> LYNRED, Actipole – CS 10021, 364 route de Valence, 38113 Veurey-Voroize, France  
Nicolas.Jamin@lynred.com

## ABSTRACT

LYNRED is a global leader in designing and manufacturing high quality infrared technologies for aerospace, defence and commercial markets. Its vast portfolio of infrared detectors covers the entire electromagnetic spectrum from near to very far infrared, especially thanks to well-mastered wavelength tuneable MCT technology. In addition, space radiation resilience of MCT technology enables LYNRED to be the leading European manufacturer for IR detectors deployed in space.

One noticeable recent trend associated to space detectors market is the increase of requested multilinear/multispectral array format (from around 1000 up to 4000 photo-elements) combined with a high frame rate need (frame time from 100 $\mu$ s up to several hundred of  $\mu$ s). However, these characteristics are generally not compatible with the current windowed 2D-large sensors off-the-shelf offer of space market especially due to technical different operating points between 2D and linear sensors. Therefore, specific recent developments have been triggered by LYNRED in order to better suit future pushbroom (generally based on several multilinear arrays) or whiskbroom (generally based on one multilinear array) instrument concepts.

One of the main challenges of this portfolio extension is to design a multilinear sensor space product line not only based on space proven building blocks heritage but also on delayed differentiation approach as much as possible. This design orientation will enable to fit optimally to the widest range of space instruments needs in a reduced time.

First of all, multilinear/multispectral sensors development is based on two pillars addressing two segments of applications in terms of flux and spectral ranges. Even if the segmentation of space application for multilinear sensor is not strictly binary, the first segment concerns Low Flux applications (named LF) whereas the second one is dedicated to High Flux (named HF). LF applications being mainly dedicated to SWIR and MWIR spectral range and HF applications oriented to space applications from MWIR up to VLWIR spectral range. The first chapter will focus on the input technical requirements for both segments and on the discussion of the main associated design challenges.

**Keywords:** INFRARED DETECTORS, SPACE SENSORS, MCT, MULTILINEAR, MULTISPECTRAL, TRISHNA, LSTM NIRSWIR, PEGA, CAPYORK

## 1 INTRODUCTION

In order to better meet technical specifications of pushbroom instruments, LYNRED has recently triggered the development of a dedicated product line of linear array detectors. Indeed, LYNRED future infrared multilinear sensors will enable to optimize pushbroom instrument performance (especially in terms of swath/frame time/SNR trade-off). The two first sensor families designed for this kind of application are named LYNRED linear CAPYORK and LYNRED linear PEGA. In addition, these two developments enable to address whiskbroom instrument which also require high frame rate (from around 100 $\mu$ s up to few hundred of  $\mu$ s). Therefore, a global approach has been followed to obtain versatile linear detectors as much as possible.

The first part of this paper will introduce this global approach and focus on the two Detector Packages (DP) currently in development i.e. LYNRED linear PEGA DP and LYNRED linear CAPYORK DP. The second and third part will present the two respective InfraRed Focal Plane Arrays (IRFPAs) which are unquestionably the major building block of linear detector.

Finally, the last part will be dedicated to packaging and Detection Cold Wiring (DCW) building blocks and also to potential possibilities of future detectors inspired from the two first acts of this product line development.

## 2 FROM PUSHBROOM INSTRUMENTS APPLICATIONS DOWN TO LYNRED LINEAR PEGA & LYNRED LINEAR CAPYORK DESIGNS

### 2.1 Global approach

First, a global technical specification has been built in order to gather all the relevant figures of merit which constitute the concept key drivers for multilinear/multispectral arrays. This technical specification has been fed by LYNRED space customers/partners and space agencies in relation with the technical needs at instrument level. The two space programs named TRISHNA and LSTM NIRSWIR currently in progress at LYNRED have supplied the major contributions of the following technical specification. However, these two specific needs have been balanced by a global approach of space linear detectors markets/applications in order to propose a future versatile product line.

As described in introduction, technical specification has been divided in two main segments of space multilinear array detector dedicated to:

- Solar infrared (SIR) applications, i.e. mainly associated to SWIR/MWIR spectral range and leading to LYNRED linear CAPYORK Detector
- Thermal infrared (TIR) applications i.e. mainly associated to MWIR/LWIR/VLWIR spectral range and leading to LYNRED linear PEGA Detector

Then, each detector building block has been derived from architecture driving requirements for the two market segments and the two instrument concept needs (pushbroom or whiskbroom). Each building block main characteristics have been traded-off considering not only instrument operating point, interfaces & environment constraints but also heritage. Indeed, the strong space & tactical detectors heritage of LYNRED (Sentinel-2, Sentinel-5, MTG FCI & IRS, METimage, Daphnis...) has enabled to propose a more secure approach in order to mitigate custom performance and consequently schedule risks (See Figure 2).

Main key inputs data deduced for LYNRED linear CAPYORK and LYNRED linear PEGA Detector designs are listed in the table hereafter:

Key input data		LYNRED Linear CAPYORK	LYNRED Linear PEGA
Spectral band	Center wavelength (µm)	NIR - SWIR - MWIR [0.9 ; 5]	MWIR - LWIR - VLWIR [5 ; 15]
Temperature	@ Detector interface (K)	[90 - 200]	[50 - 100]
Input Flux	Flux range (ph/s/pix)	[1E5 ; 1E9]	[1E8 ; 1E11]
Functions / Interfaces	Cooler	Yes (Option) or No	
	Spectral filters	Yes (Option) or No	
Format	Number of channels	1 to 4	1 to 4
	Number of columns	1200	600
	Number of lines per channel	1	1 to 3
	TDI number (on-chip)	2 to 12	NA
	Pixel size & pitch (µm)	15	30
	Spectral channel pitch (mm)	4.02	4.02
Timing	Butting and staggering compatibility (Push Broom instrument concept)	Yes	
	Frame time (µs)	> 100 µs	
	Acquisition mode	Integration While Read (IWR) Mode	
	Integration time adjustment	Integration time adjustment available per channel	
Environment	Number of thermal cycles	> Several hundred of thermal cycles [Operating Temperature; Ambient Temperature]	
	Humidity, temperature exposure	2500h under AIT environment conditions (Temperature: 22°C +/- 3°C, Relative humidity: 40% to 60%, Pressure: 970 to 1050 mbar, Cleanliness ISO Class 5)	
	Radiation	Maximum Total Ionizing Dose (TID): [5 ; 20 krad(Si)] Maximum Total Non Ionizing Dose (TNID): [1e10 ; 6e10] protons/cm² @ 60MeV SEE robustness: SEL free / Low SEU & SEFI rate	

Table 1: Key input data for LYNRED linear CAPYORK and LYNRED linear PEGA Detectors

Finally, it is important to notice that a design for test approach has been followed and especially led for ROIC and Detection Circuit. This approach has been chosen to secure early in the development program the performance of each building block and the panel of requested test & manufacturing means.

### 2.2 LYNRED linear PEGA & LYNRED linear CAPYORK DP architecture overview

Based on key inputs data presented in Table 1, two DPs have been designed and are currently developed in the frame of TRISHNA and LSTM NIRSWIR programs at LYNRED. These two DPs can be considered as the first two pillars of LYNRED linear detectors product line.

The product trees of LYNRED linear PEGA and LYNRED linear CAPYORK rely on a common architecture which is based on three specific main assemblies:

- The IRFPA (InfraRed Focal Plane Array) which aims to detect incident photon flux by HgCdTe (MCT) photodiodes and to process/deliver the photocurrent up to interconnection ceramic. Both IRFPAs will be described in details in sections §3 & §4.
- The open Package constituted by three sub-assemblies: a baseplate, an electrical interconnection ceramic and a bonding protective cap.
- The DCW (Detection Cold Wiring) constituted by the assembly of three elements: the Flex fixation which mechanically maintains the flex rigid part, the flex cable and the connector.

The next figure illustrates the two similar product trees of LYNRED linear PEGA and LYNRED linear CAPYORK DP:

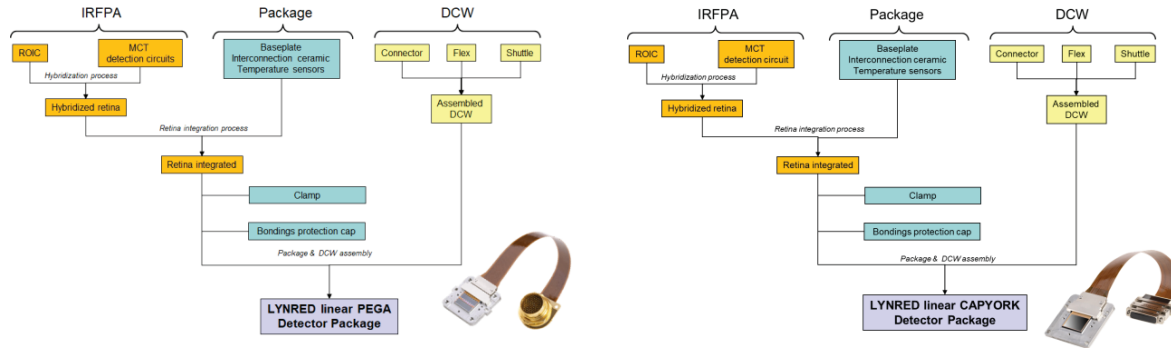

Figure 1: LYNRED linear PEGA DP & LYNRED linear CAPYORK Product Trees

Finally, as mentioned previously, each Linear Detector (LD) benefits from a strong heritage relying not only on space programs from SWIR to VLWIR but also on tactical product especially for advanced high performances silicon technologies used by ROIC. The next figure details for each building block the corresponding program or/and infrared detector involved in LYNRED linear PEGA and LYNRED linear CAPYORK heritage:

	LYNRED linear CAPYORK	LYNRED linear PEGA
<b>Detection Circuit</b>	Sentinel-2 NGP (Sentinel-5, MicroCarb)	MTG FCI & IRS METImage LVWIR
<b>ROIC</b>	Tactical products (Daphnis) Sentinel-2 NGP (Sentinel-5, MicroCarb) MTG FCI	Tactical products (Daphnis) METImage MTG FCI
<b>IRFPA</b>	NGP (Sentinel-5, MicroCarb) Tactical products (Daphnis)	METImage Tactical products (Daphnis)
<b>Package &amp; DCW</b>	MTG IRS METImage Sentinel-5 MicroCarb	MTG IRS METImage

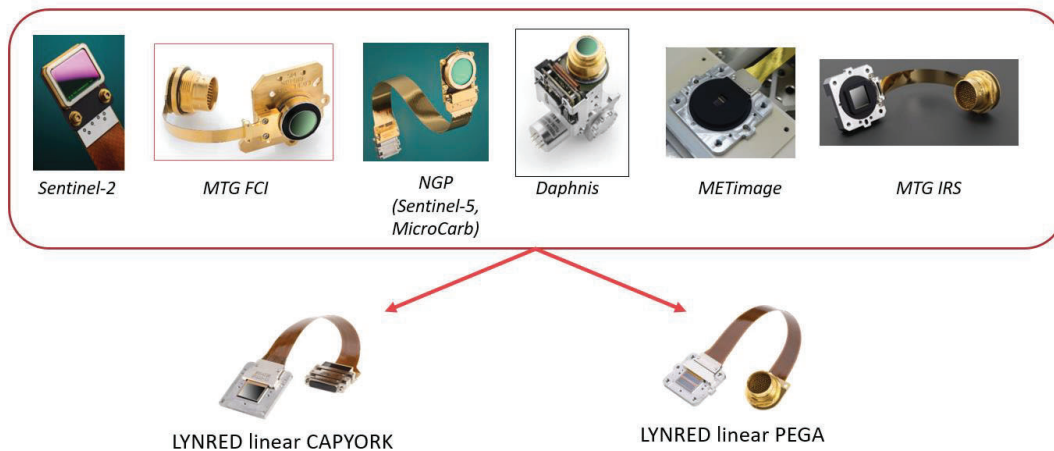

Figure 2: LYNRED linear CAPYORK & LYNRED linear PEGA Detectors heritage

### 3 FOCUS ON LYNRED LINEAR PEGA IRFPA

#### 3.1 Global design description

Considering main TRISHNA mission key requirements (e.g. spectral wavelength of TIR bands, [1]) and LYNRED heritage, sensitive area of LYNRED linear PEGA IRFPA is made of two detection circuits based on n/p HgCdTe technology (30µm x 30µm pitch), as described in Figure 4 and named:

- LWIR detection circuit covering TIR1 & TIR2 bands (= DC1)
- VLWIR detection circuit covering TIR3 & TIR4 bands (= DC2).

MCT detection circuits are hybridized, following LYNRED standard hybridization process, onto a common Read-Out Integrated Circuit (ROIC). The composition of the two MCT layers is tuned in order to reach the best trade-off in terms of performance (Quantum Efficiency, PRNU, Dark Current...) and heritage (already qualified HgCdTe stoichiometry).

A ZnS mono-layer anti-reflective coating is deposited on both detection circuits to optimize the mean transmission of all channels. FPA temperature considered for all performance assessment has been settled @ 60.5K. This FPA temperature is based on a customer thermal link @60K and considering a worst case of additional thermal gradient of 0.5K between customer thermal link and IRFPA.

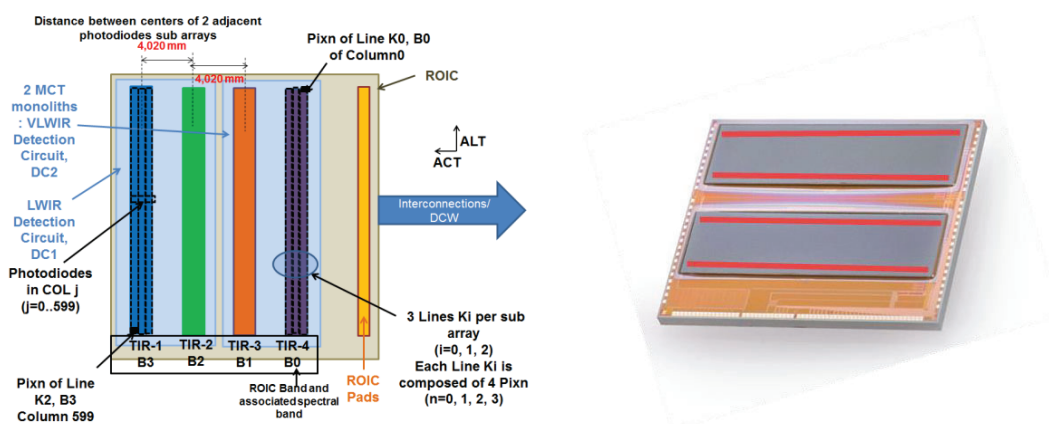

Figure 3: LYNRED linear PEGA IRFPA Sketch & Picture

#### 3.2 Focus on main building blocks and associated performance

##### 3.2.1 LYNRED linear PEGA Detection Circuits (DC)

The next paragraphs will be dedicated to specific focuses on analyses/justifications of main E-O driving characteristics/requirements (such as dark current, quantum efficiency, etc...) related to LYNRED linear PEGA detection circuits.

- HgCdTe stoichiometry (Spectral Response cut-off wavelength): The cut-off wavelength of each DC is driven by the detection layer itself. Indeed, via the adjustment of the Cd/Hg ratio in the Mercury Cadmium Telluride layer, the cut-off of the detector can be tuned continuously from SWIR range to VLWIR detection ranges. The requirement would ask here for a material cut-off wavelength higher than the last spectral channel, that is to say the TIR4 channel (from 11.1µm up to 12.1µm). However, dark current contribution is major in LWIR/VLWIR range and has to be taken into account in order to define the optimized distribution of TIRx bands over one single or two MCT monoliths. To allow performance optimisation on all bands and based on LYNRED heritage, two existing and already HgCdTe stoichiometry relying on respectively:
  - 9.8µm cut-off wavelength @60.5K for LWIR detection circuit (TIR1 and TIR2)
  - 12.7µm cut-off wavelength @60.5K for VLWIR detection circuit (TIR3 and TIR4)

The next figure illustrates typical normalized spectral responses of the two detection circuits:

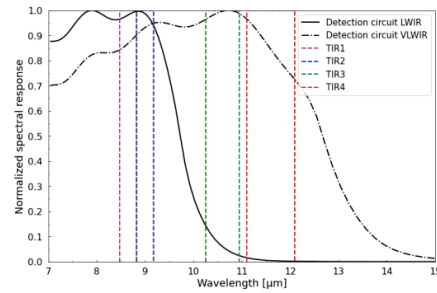

Figure 4: Typical normalized spectral responses of LYNRED linear PEGA detection circuits at 60.5K

- Dark current density: As previously described above, the proposed concept for LYNRED linear PEGA IRFPA relies on two detection circuits (LWIR and VLWIR). Therefore, this enables to assess with a better level of confidence the expected level of dark current density @60.5K for the two detection circuits. Dark current density characteristic is one of the major contributors to SNR performance (especially for VLWIR spectral range). Next figure illustrates expected dark current densities values vs FPA temperature for LWIR & VLWIR detection circuits:

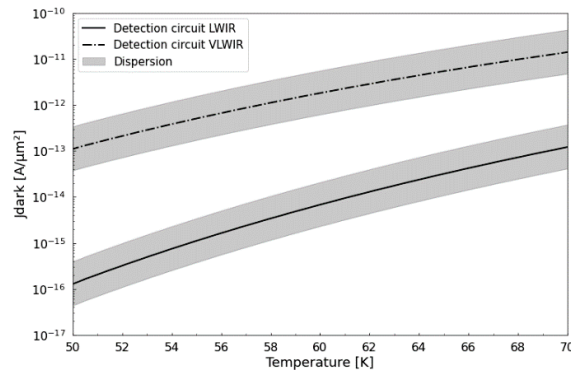

Figure 5: Typical Dark current densities of LYNRED linear PEGA detection circuits

- Reflectivity and Anti-Reflective coating (Mono-layer AR coating): Following the monolayer approach, the thickness of the ZnS quarter-wavelength anti-reflective coating is optimized to minimize the average reflectivity over all channels. As a baseline, the same AR coating thickness for both LWIR and VLWIR detection circuits has been considered due to the low added-value in terms of reflectivity/transmission performance. The next figure shows the evolution of reflectivity w.r.t. to wavelength for the selected thickness:

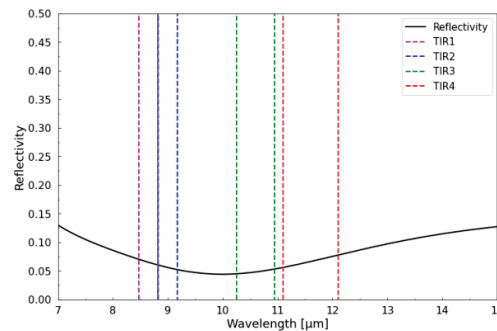

Figure 6: Reflectivity performance of LYNRED linear PEGA IRFPA

- Spectral Detection Efficiency (SDE) & Photo-Response Non Uniformity (PRNU): SDE is defined as the ratio of the amount of collected electrons over the amount of incident photons considering ideal fully sensitive photodiode areas. SDE includes geometrical fill factor and photodiode Quantum Efficiency. The figure hereafter presents typical SDE evolution vs wavelength for the two detection circuits. Besides, the PRNU, considered as



the standard deviation of the photoresponse has been estimated below 3% for LWIR DC and below 5% for VLWIR DC.

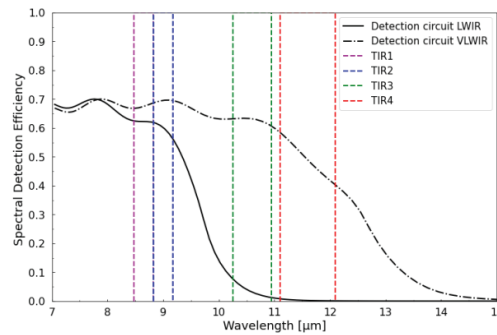

Figure 7: Typical SDE of LYNRED linear PEGA LWIR & VLWIR detection circuits @60.5K

- **Modulation Transfer Function (MTF):** The 30 $\mu$ m pitch MTF has been largely studied and is well mastered at LYNRED ([2] & [3]). MTF results obtained with close proposed material cut-off wavelength of LWIR & VLWIR detection circuits are available for 30 $\mu$ m pitch. Typical MTF values at the Nyquist frequency are geometrical MTF limited (0.64). The following figure illustrates typical MTF performance (evaluated from measurements) compared to expected performance on LYNRED linear PEGA DP:

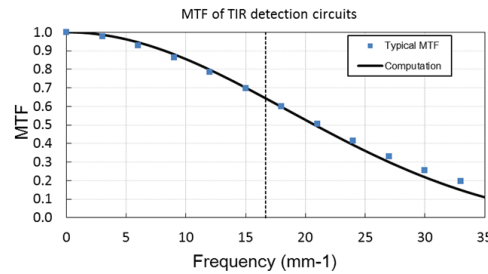

Figure 8: Typical MTF of LYNRED linear PEGA detection circuits @60.5K (Vertical line corresponds to the Nyquist frequency)

### 3.2.2 LYNRED linear PEGA ROIC

The main specific building block for LYNRED linear PEGA Detector is the ROIC. Indeed, this ROIC has been designed specifically for applications based on multispectral/multilinear infrared sensor. The design of this ROIC has been performed in order to suit TRISHNA mission needs while offering versatility to answer future TIR programs.

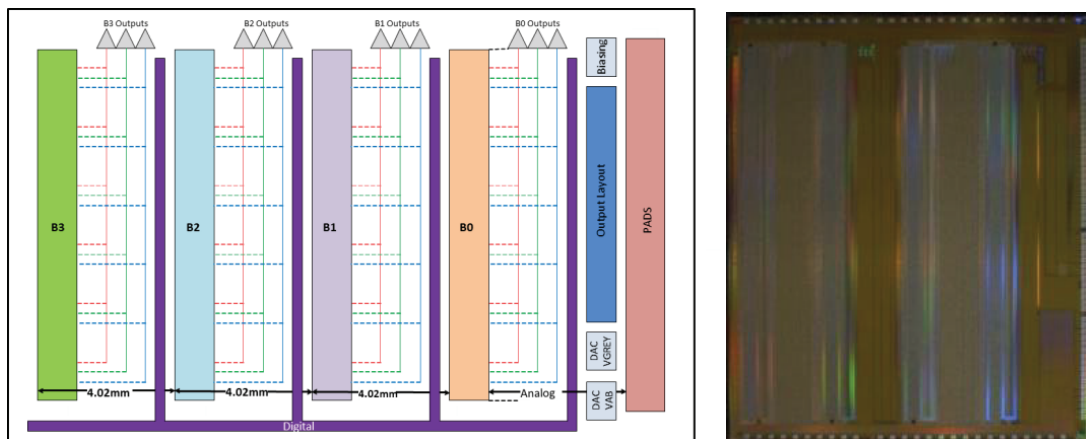

Figure 9: LYNRED linear PEGA ROIC Synoptic view & Picture

- **ROIC architecture & Main characteristics:** The pixel array is constituted of 4 bands (named B0 to B3) of 600 x 3 pixels distributed over 12 outputs. The three available ReadOut (RO) lines per band/channel enable the user to

perform external TDI (Time Delay Integration) for SNR optimization if necessary. The channel pitch is 4.02mm as mentioned in Figure 9. Each band can be totally deactivated in order to save power dissipation if not used. Besides, buttability constraints related to pushbroom application (See Table 1) are also taken into account. The distance between first active pixel of B3 and edge of ROIC is less than 1mm and electrical pads are implemented only on one side of the ROIC. TIR LD ROIC has been designed with advanced high performances CMOS technology combined with radiation hardening strategy inherited from previous space programs.

- **Analog chain:** Photodiode biasing is done by a CTIA (Capacitive TransImpedance Amplifier) input stage. Following reset of the selected CTIA integration capacitance, the photodiode current is integrated in this capacitance and converted as a voltage at CTIA output. The conversion gain depends on the integration capacitance chosen by the user. Three different capacitances are available, providing up to 8 (7 operational and one for test purpose) gains values from 3 Me- up to 18 Me-. Currents of any selected photodiode are integrated simultaneously (Snapshot mode). The voltage information (proportional to the current from the selected photodiode among four, See Figure 10) is stored on the integration capacitance and then read through a video amplifier considering a maximum output swing of 2.6V. In addition, an anti-blooming system allows controlling the saturation level of the pixel output.

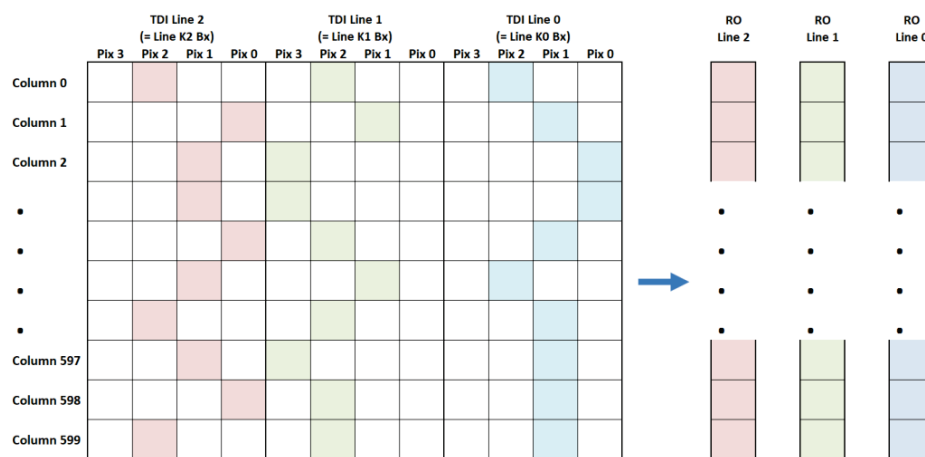

Figure 10: Focus on one band (Illustration of photodiode selection for each RO line)

- **Digital Part:** The digital block generates the required internal digital signals necessary for integration and readout sequence. The serial programming interface is integrated into this block. The serial link implemented in the ROIC uses a SPI (Serial Peripheral Interface) physical link. Above this physical link, a protocol address data to access a memory mapped register file is implemented. This allows reading and writing the state of the ROIC at byte granularity. The same clock (typical design value of 4 MHz corresponding to a TDI line framerate of around 175 $\mu$ s) is used for Master Clock and SPI in order to avoid any temporal artefacts. The SPI programming is used to set the requested configuration as for example:
  - Pixel selection in order to reach 100% operability.
  - Power management of the input stages and video output amplifiers.
  - Integration time adjustment for each spectral channel and for each readout line.
  - Gain selection. For each spectral channel the gain can be adjusted in order to fit to the different fluxes.
  - Turn on or off the TDI readout lines for each spectral channel.
- **ROIC Performance (Noise and Power Dissipation):** Simulations of typical total ROIC readout noise are reported in the figure hereafter.



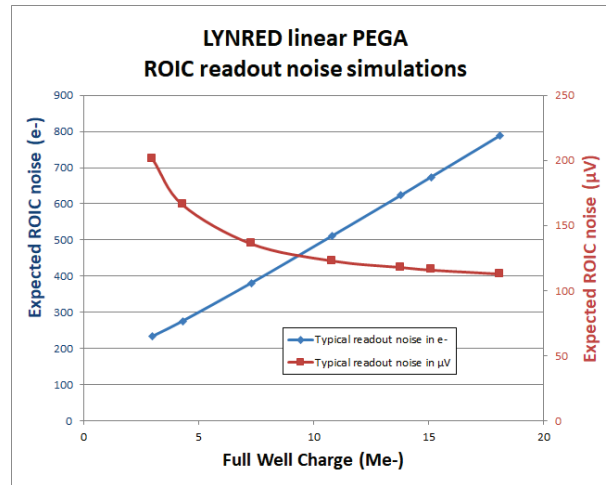

Figure 11: LYNRED linear PEGA ROIC readout noise simulations at 4MHz for 60K operation

LYNRED linear PEGA ROIC power dissipation has been simulated around 140-150mW for 12 activated RO lines. The expected gain with one RO line switch off is around 10mW.

### 3.3 LYNRED linear PEGA IRFPA concept key parameters & validation status

The next table summarizes the main typical concept key parameters of LYNRED linear PEGA IRFPA tailored to TRISHNA mission requirements (especially spectral channels requirements):

		LYNRED linear PEGA IRFPA			
		TIR-1	TIR-2	TIR-3	TIR-4
Spectral band	Center wavelength (µm)	8.65	9	10.6	11.6
	Spectral width (nm)	350	350	700	1000
Temperature	FPA Temperature (K)	60.5K	60.5K	60.5K	60.5K
Format	Number of Columns	600	600	600	600
	Number of Rows	12	12	12	12
	Pixel Size (µm)	30	30	30	30
	Pixel pitch (µm)	30	30	30	30
Timing	Spectral channel pitch (mm)	4.02	4.02	4.02	4.02
	Frame Time (µs)	> 230	> 230	> 230	> 230
Detection circuits Key parameters	Name	Detection circuit LWIR		Detection circuit VLWIR	
	Lc @ Tfpa (µm)	9.8	9.8	12.7	12.7
	SDE Band	0.65	0.60	0.61	0.47
	PRNU (%)	3%	3%	5%	5%
	Idark density (A/µm²)	1.95E-14	1.95E-14	2.80E-12	2.80E-12
	DSNU (%)	10%	10%	10%	10%
	MTF (@ Nyquist)	> 0.6	> 0.6	> 0.6	> 0.6
Reflectivity mean (%)	4.1	3.2	3.3	5.1	
ROIC Key parameters	Activated RO Lines (External TDI number)	2	1	3	3
	Selected FWC (Gain number)	4.3 Me- (Gain 2)	4.3 Me- (Gain 2)	18.1 Me- (Gain 7)	18.1 Me- (Gain 7)
	Maximum useful output	2.6V			
	Integration capacitance (ff)	265	265	1115	1115
	ROIC Noise (µV)	< 166	< 166	< 113	< 113
Power dissipation		< 125 mW (Total for TRISHNA DP, 9 RO Lines ON)			

Table 2: LYNRED linear PEGA IRFPA typical concept Key parameters

Validation status: Validation at ROIC level at 300K and 60.5K has been successfully conducted. For information, digital performance has been checked up to 8 MHz with no encountered blocking point. The validation of key parameters at IRFPA level (especially for detection circuit and ROIC building blocks) is currently in progress. Preliminary results are encouraging and first evaluated figures of merit are in line with expected performance (Dark current, ROIC noise, ROIC robustness to heavy ions for example). The next figure highlights first responsivity measurements on one typical IRFPA showing 100% operability performance for all readout lines of both detection circuits (operability based on standard LYNRED criteria, i.e. pixels considered as noise defects outside mean value +/- 100%, responsivity and output signal defects outside mean value +/- 30%).

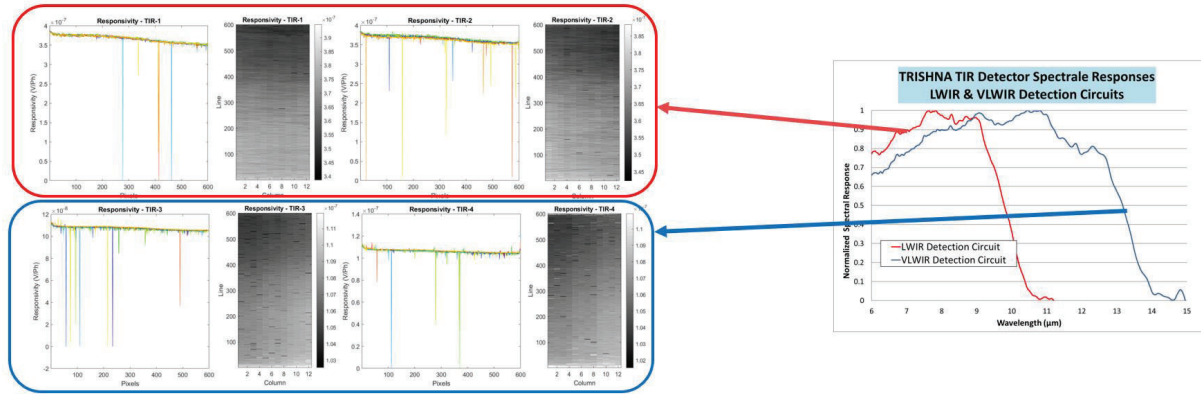

Figure 12: First responsivity and spectral response results of LYNRED linear PEGA

## 4 FOCUS ON LYNRED LINEAR CAPYORK IRFPA

### 4.1 Global design description

Contrary to LYNRED linear PEGA IRFPA and due to reduced dark current contribution in SWIR channel vs photonic flux (See LSTM mission requirements, [4]), LYNRED linear CAPYORK IRFPA relies on one single detection circuit based on n/p HgCdTe technology (15μm x 15μm size and pitch), as described in Figure 13.

MCT detection circuit is hybridized, following LYNRED standard hybridization process, onto a specific ROIC based on the same silicon technology as used for LYNRED linear PEGA ROIC. The composition of the MCT layer is tuned in order to benefit from the strong heritage of LYNRED space detectors for SWIR products [5].

A ZnS mono-layer anti-reflective coating is deposited on detection circuit to optimize the mean transmission and reflectivity of all NIRSWIR channels.

FPA temperature considered for all performances assessment has been settled @ 200K.

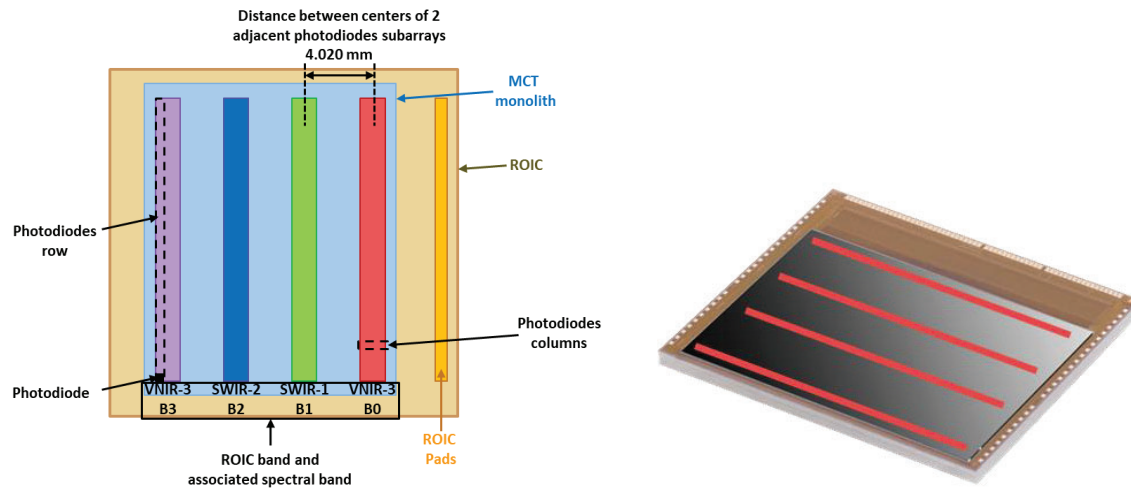

Figure 13: LYNRED linear CAPYORK IRFPA (Sketch & Picture)

### 4.2 Focus on main building blocks and associated performance

#### 4.2.1 LYNRED linear CAPYORK Detection Circuit (DC)

The next paragraphs will mainly focus on presentation of E-O driving characteristics and requirements (such as dark current, quantum efficiency, etc...) related to LYNRED linear CAPYORK detection circuit.

- HgCdTe stoichiometry (Spectral Response cut-off wavelength): The selected cut-off wavelength corresponds to the standard 2.5μm stoichiometry point for SWIR products at LYNRED. This enables to benefit from the same

detection circuit for all bands (VNIR-3, SWIR-1 & SWIR-2). The next figure illustrates typical normalized spectral response of the detection circuit:

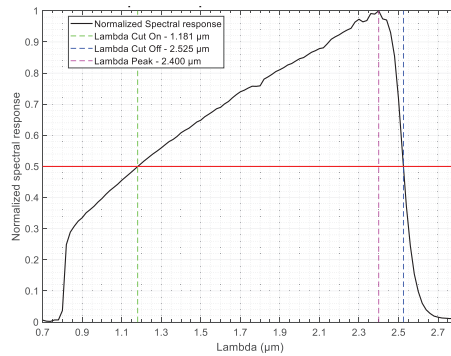

Figure 14: Typical normalized spectral response of LYNRED linear CAPYORK detection circuit at 200K

- Dark current density: Even if dark current is generally less critical for SIR applications compared to TIR applications, dark current contribution to the global signal can be close to minimum photonic flux. Therefore, a close follow-up of this performance remains necessary for this purpose. Next figure illustrates dark current density typical for LYNRED linear CAPYORK detection circuit:

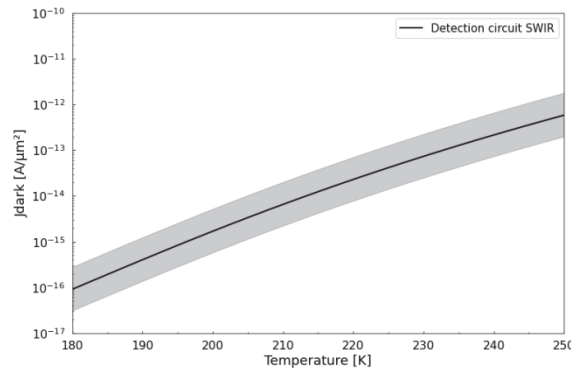

Figure 15: Typical Dark current density of LYNRED linear CAPYORK detection circuit

- Spectral Detection Efficiency (SDE) & Photo-Response Non Uniformity (PRNU): As defined in §3.2.1, the figure hereafter presents typical SDE evolution vs wavelength for LYNRED linear CAPYORK detection circuit. Besides, the PRNU, expressed as the standard deviation of the photoresponse has been estimated below 5%.

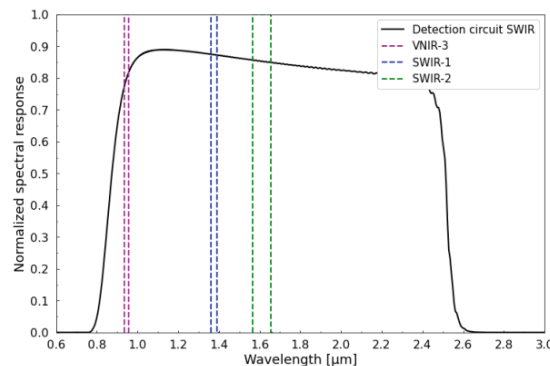

Figure 16: Typical SDE of LYNRED linear CAPYORK detection circuit @200K

- Modulation Transfer Function (MTF): The 15 $\mu$ m pitch MTF has been largely studied and is well mastered at LYNRED. Typical MTF values at the Nyquist frequency are about 0.46 at pixel level. The following figure illustrates typical MTF performance (evaluated from simulation & measurements):

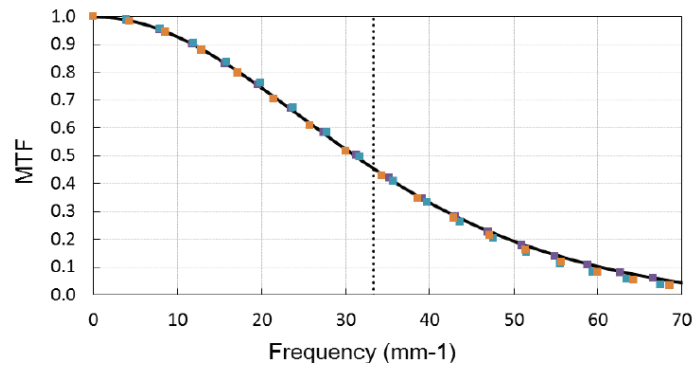

Figure 17: Typical MTF of LYNRED linear CAPYORK detection circuit (Vertical line corresponds to the Nyquist frequency)

#### 4.2.2 LYNRED linear CAPYORK ROIC

By analogy with LYNRED linear PEGA detector, the main specific building block for LYNRED linear CAPYORK detector is the ROIC. Indeed, this ROIC has been as well designed specifically for space applications based on multispectral/multilinear infrared sensor. The ROIC design has been driven by LSTM mission but has as well taken into account key input data summarized in Table 1. Indeed, common characteristics (e.g. ROIC format, channel pitch, distance between 1st active pixel of B3 and edge of ROIC) have been encouraged in order to address potential mission with mix of SIR & TIR missions. In addition, this enables also to benefit from common tools and means between LYNRED linear CAPYORK and LYNRED linear PEGA ROICs due to similar format and pad ring implementation.

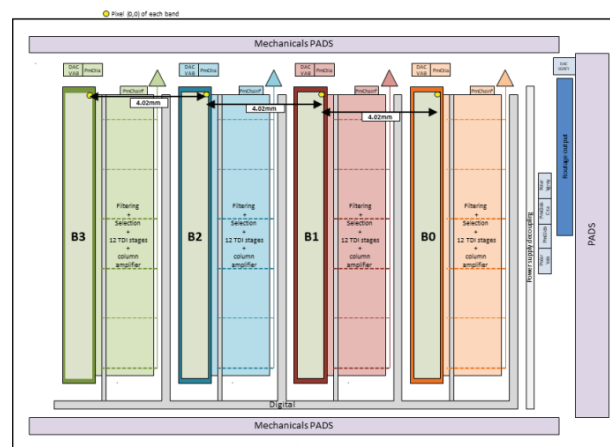

Figure 18: LYNRED linear CAPYORK ROIC Synoptic view

- ROIC architecture & Main characteristics: The pixel array is constituted of 4 bands (named B0 to B3) of 1200 x 1 TDI readout pixel (on chip TDI up to 12 stages) distributed over 4 outputs. The channel pitch is 4.02mm as mentioned in Figure 10). Each band can be totally deactivated in order to save power dissipation if not used. Besides, buttability constraints related to pushbroom application (See Table 1) are also taken into account. The distance between first active pixel of B3 and edge of ROIC is less than 1mm and electrical pads are implemented only on one side of the ROIC. LYNRED linear CAPYORK ROIC has been designed following a similar approach as LYNRED linear PEGA ROIC (same silicon technology and radiation hardening strategy inherited from previous space programs).
- Analog chain: By analogy with LYNRED linear PEGA ROIC, photodiode biasing is done by a CTIA (Capacitive TransImpedance Amplifier) input stage. The conversion gain depends on the integration capacitance

chosen by the user. Currents of the 12 photodiodes of each TDI column are integrated simultaneously (Snapshot mode). Two different capacitances are today available, providing up to 4 (3 operational and one for test purpose) gains values from around 150ke- up to 350 ke-. In addition, an anti-blooming system is also available in order to control the saturation level of the pixel output. Contrary to LYNRED linear PEGA ROIC, every photodiode is selected by default and a deselection is possible in order to optimize SNR performance and to reach 100% operability. Deselected photodiode is then connected to a specific reference voltage. After the photodiode selection block, the analog chain is composed of 12 sample & hold (SH) stages, which are responsible to sample and hold voltage information coming from CTIA output stage. Then, the next 12 downstream TDI stages will temporally average the delayed information which will be finally sampled and stored in ping pong capacitors through the column amplifier, until the on chip reconstructed TDI data are readout via the video amplifier (Maximum useful output swing of 2.1V). Thus, one TDI readout pixel per column will be available at the ROIC output based on the information of the 12 photocurrent successively integrated on the 12 CTIA stages from the same TDI column (See Figure 19).

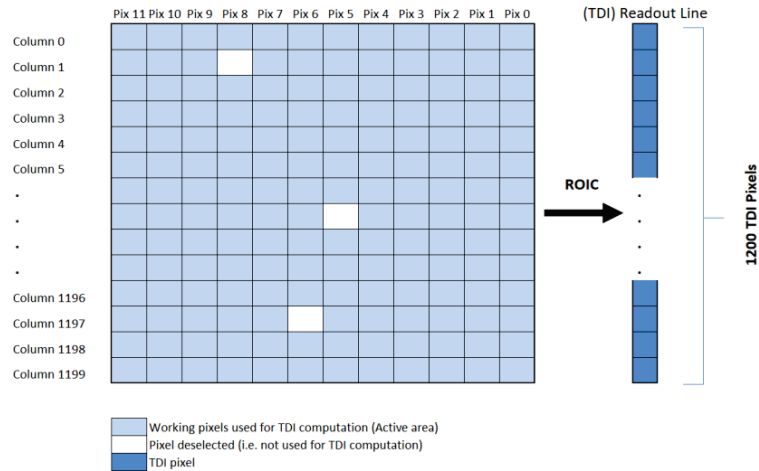

Figure 19: Focus on one band (Illustration of photodiode selection for each RO line)

- **Digital Part:** The digital part has been designed by analogy with LYNRED linear PEGA ROIC and considering specificities (especially photodiode deselection and TDI management). The serial link implemented in the ROIC uses a SPI (Serial Peripheral Interface) physical link. The MCLK frequency (equal to SPI frequency if used) is 5.5 MHz (corresponding to a TDI line framerate of around 240µs). The SPI programming enables to set the requested configuration as for example:
  - Photodiode deselection
  - Power management of the input stages, TDI stages and video output amplifiers (including band turn off).
  - Bi-directional TDI
  - Integration time adjustment for each spectral channel.
  - Gain selection.
- **ROIC Performance (Noise and Power Dissipation):** The major contributor to SNR performance for SIR applications is the ROIC readout noise. Indeed, this can be explained by operating point of SIR applications which relies on combination of low level of input fluxes, frame time around 200-300µs and dark current managed by selecting adequate focal plane array temperature. LYNRED linear CAPYORK ROIC typical power dissipation has been simulated around 250mW for 4 activated TDI readout lines. The expected gain with one readout line switch off is around 55mW.

Full Well Capacity	147	220	351	ke-
Typical readout noise in e-	29	37	52	e-
Typical readout noise in µV	407	347	311	µV

Table 3: LYNRED linear CAPYORK ROIC readout noise simulations at 5.5MHz for 200K operation (considering 12 TDI stages)

### 4.3 LYNRED linear CAPYORK IRFPA concept key parameters & validation status

The next table summarises the main concept key parameters of LYNRED linear CAPYORK IRFPA tailored to LSTM SWIR mission requirements:

		LYNRED linear CAPYORK IRFPA		
		VNIR-3	SWIR-1	SWIR-2
Spectral band	Center wavelength (μm)	0.945	1.375	1.61
	Spectral width (nm)	20	30	90
Temperature	FPA temperature (K)	200K	200K	200K
Format	Number of Columns	1200	1200	1200
	Number of Rows	12	12	12
	TDI Number (on-chip)	12	12	12
	Pixel Size (μm)	15 x 15	15 x 15	15 x 15
	Pixel pitch (μm)	15	15	15
Timing	Spectral channel pitch (mm)	4.02	4.02	4.02
	Frame Time (μs)	> 250	> 250	> 250
Detection Circuit Key parameters	Name	Detection Circuit NIRSWIR		
	Lc (Typical) @ Tfpa	2.52	2.52	2.52
	SDE Band	0.80	0.87	0.85
	PRNU (%)	4%	4%	4%
	Idark density (A/μm <sup>2</sup> )	1.20E-15	1.20E-15	1.20E-15
	DSNU (%)	15	15	15
ROIC Key parameters	MTF (@ Nyquist)	0.46	0.46	0.46
	Selected FWC (Gain number)	147 ke- (Gain 1)	147 ke- (Gain 1)	351 ke- (Gain 3)
	Maximum useful output voltage swing		2.1V	
	Integration capacitance (fF)	11.2	11.2	26.8
	ROIC noise after TDI (μV)	< 407	< 407	< 311
	Power dissipation	< 250 mW		

Table 4: LYNRED linear CAPYORK IRFPA concept Key parameters

Validation status: First tests of ROIC performances have been made successfully at 300K. Full validation tests for ROIC and IRFPA at operating temperature are planned in 2022.

## 5 FOCUS ON PACKAGE AND DCW BUILDING BLOCKS FOR LYNRED LINEAR PEGA AND LYNRED LINEAR CAPYORK DETECTORS

As described in Figure 1, the other building blocks integrated in LYNRED linear PEGA & LYNRED linear CAPYORK detectors are the package and DCW. By analogy with IRFPA development, package and DCW have been respectively inherited from MTG IRS/METimage and Sentinel-5 programs. This enabled to not only accelerate the design phase but also manufacturing & testing phase due to compatibility of existing mechanical and thermal interfaces.

As robustness of simple open package concept (baseplate + electrical interconnection ceramic) has been demonstrated for MTG IRS and METimage programs, this approach has been extended to LYNRED linear CAPYORK detector in the frame of LSTM program. However, even if rigid-flex technology has been kept for both detectors, the design of the flex has been tailored in order to suit to electrical interface of each IRFPA. Finally, the connector technology remains also different between the two families (Deutsch connector for LYNRED linear PEGA detector and Glenair for LYNRED linear CAPYORK detector) due to hermeticity constraint and heritage.

The next pictures illustrate a global view of the two first detectors.



Figure 20: LYNRED linear PEGA DP (left side) & LYNRED linear CAPYORK DP (right side)



One can notice that LYNRED linear PEGA package and LYNRED linear CAPYORK package have been designed considering whiskbroom instrument concept based on single DP at focal plane. Indeed, the butting and staggering compatibility of the package (associated to pushbroom instrument concept) will be introduced in a second time. This next version of package concept will benefit from the already implemented reduced distance between first active photodiode and edge of ROIC, See §3.1 & §4.1).

## 6 CONCLUSION

As a conclusion, this paper presents the two first chapters of the two linear infrared detectors families. The first one named LYNRED linear PEGA pulled by TRISHNA program and the second one named LYNRED linear CAPYORK pulled by LSTM program. The selected flexible design approach combined with LYNRED heritage in terms of space and tactical MCT sensors portfolio offers multiple possibilities for next chapters. Thus, future potential sensors could be easily and quickly derived from the two major building blocks (especially IRFPAs). For example, as LYNRED linear PEGA and LYNRED linear CAPYORK ROICs have been designed in parallel (common pad ring and same dimensions, same sensitive array dimensions in mm due to pixel pitch and column number ratio), a mix of TIR and SIR channels could be easily considered at instrument level in order to cover all spectral range from NIR up to VLWIR (i.e. SIR & TIR mix observation scenario). Extensions of LYNRED linear detectors product line will be adjusted in function of the future need of LYNRED customers for space instruments but also for any other type of imaging system.

## ACKNOWLEDGEMENTS

The authors thank not only all the LYNRED teams dedicated to LYNRED linear PEGA and LYNRED linear CAPYORK detectors development but also LSTM and TRISHNA program teams at customer level (French space agency (CNES) and Airbus DS for TRISHNA and European Space Agency (ESA) / European Union and Airbus DS for LSTM) for their support and fruitful collaboration.

## REFERENCES

- [1] L. Buffet et al., The TIR instrument on TRISHNA satellite: a precursor of high resolution observation missions in the thermal infrared domain, ICSO 2020
- [2] L. Martineau, L., Rubaldo, L., Chabuel, F., & Gravrand, O. (2013, October). *MTF optimization of MCT detectors*. In *Sensors, Systems, and Next-Generation Satellites XVII* (Vol. 8889, pp. 309-318)
- [3] J. Berthoz, R. Grille, L. Rubaldo, O. Gravrand, A. Kerlain, N. Pere-Laperne, L. Martineau, F. Chabuel and D. Leclercq, “*Modeling and Characterization of MTF and Spectral Response at Small Pitch on Mercury Cadmium Telluride*”, *Journal of electronic material*, VOL. 44 NO 9, P. 3157-3162 (2015)
- [4] LSTM mission requirements  
[https://www.esa.int/Applications/Observing\\_the\\_Earth/Copernicus/Copernicus\\_Sentinel\\_Expansion\\_missions](https://www.esa.int/Applications/Observing_the_Earth/Copernicus/Copernicus_Sentinel_Expansion_missions)
- [5] Cédric Leroy, Bruno Fièque, Nicolas Jamin, Philippe Chorier, *SWIR space detectors and future developments at SOFRADIR*, Proc. SPIE [8889-44], Dresden (2013)