

International Conference on Space Optics—ICSO 2018

Chania, Greece

9–12 October 2018

Edited by Zoran Sodnik, Nikos Karafolas, and Bruno Cugny



In-orbit demonstration of fiber optic sensors based on Bragg gratings

Raquel López Heredero

Malte Frövel

Hugo Laguna

Tomás Belenguer



icso proceedings



In-Orbit demonstration of fiber optic sensors based on Bragg gratings

Raquel López Heredero^{*a}, Malte Frövel^b, Hugo Laguna^a and Tomás Belenguer^a

^aOptical Space Area, Department of Payloads and Space Sciences; ^bDepartment of Structures and Materials
Instituto Nacional de Técnica Aeroespacial (INTA), Ctra. Ajalvir km 4, 28850 Torrejón de Ardoz,
Madrid, SPAIN

ABSTRACT

FIBOS (Fiber Bragg gratings for Optical Sensing) is one payload used to monitor temperature and strain during a nanosatellite mission. Description of the payload and in-orbit results are presented.

Fiber Bragg Grating (FBG) sensors offer attractive and robust solutions for temperature and pressure monitoring in a spacecraft. Moreover, they can be embedded in composite structures or attached on their surface for structural health monitoring during the entire life cycle of a satellite, from integration and qualification tests, to final operation.

FIBOS contains two FBGs to measure temperature and strain during one space mission called OPTOS. The mission, developed by INTA (Instituto Nacional de Técnica Aeroespacial), was a low-cost nanosatellite based on a triple configuration (3U) of the popular Cubesat standard. OPTOS was launched in November 2013 and was operative during two years. Its main goal was to validate and demonstrate the suitability of novel technologies for space applications inside a miniaturized area with big restrictions in terms of mass and power consumption.

This work describes the payload components. FIBOS contains commercial off-the-shelf (COTS) parts like a monolithic tunable laser and a conventional InGaAs pigtailed photodiode. The optical sensor head includes two FBGs mounted onto a steel mechanical structure to monitor temperature and strain. Results of the mission are presented. Measurements performed during the operation in-orbit show good agreement with calibration data performed on earth inside a thermal-vacuum chamber (TVC). This paper shows a demonstration of a fiber optic sensor based on FBGs in space environment.

Keywords: Fiber optic sensors, Fiber Bragg Gratings, optical payloads, space mission

1. INTRODUCTION

Fiber Bragg Grating (FBG) sensors have delivered outstanding performance for applications in many fields of industry, engineering and science. Their use have greatly increased in the last two decades offering alternatives to traditional sensors based on electronic devices for sensing purposes. They have experienced a great development in structural health monitoring applications and in industrial sectors for remote sensing where the environment is harsh, like in oil and gas industry and nuclear reactors¹.

In space applications, the use of fiber optic sensors is not widely spread even if the space agencies have been using fiber optics for more than 30 years in space, generally used to transmit data in telecommunications applications or to guide the light for illumination purposes².

The space environment is a harsh scenario and sensors based on fiber optics present great advantages as electromagnetic immunity, possibility of multiplexing and weight saving by removing copper harness³. Among all the optical fiber sensors, FBGs are very appropriate and advantageous since their optical response is wavelength-coded and therefore, their response is independent of the optical power of the light source, the eventual loss of energy transmitted along the optical fiber and

*lopezhr@inta.es; phone + 34 91 520 12 74

of the response of the photodetector (PD). The use of these sensors for space applications has been subject of interest for space agencies such as ESA by financing several development programs and activities.

As far as the authors know, FIBOS is one of the first payloads in a space application based in fiber optic sensors with successful results during the mission. The scientific data obtained demonstrate the capability of this technology for space application.

2. MISSION

OPTOS, developed by INTA (Instituto Nacional de Tecnica Aeroespacial), was a low-cost triple-cube nanosatellite with an external structure that corresponds to the triple CubeSat format (3U) in size and mass, i.e. 10 cm x 10 cm x 34.5 cm, and ~ 3.8 kg (Figure 1). The composite material structure made of IM7/MTM45-1 fabric minimized the structural weight, provided a thermally stable structure with a very low coefficient of thermal expansion and avoided shielding of the magnetic measurements of the integrated Giant Magneto-Resistance (GMR) sensor.

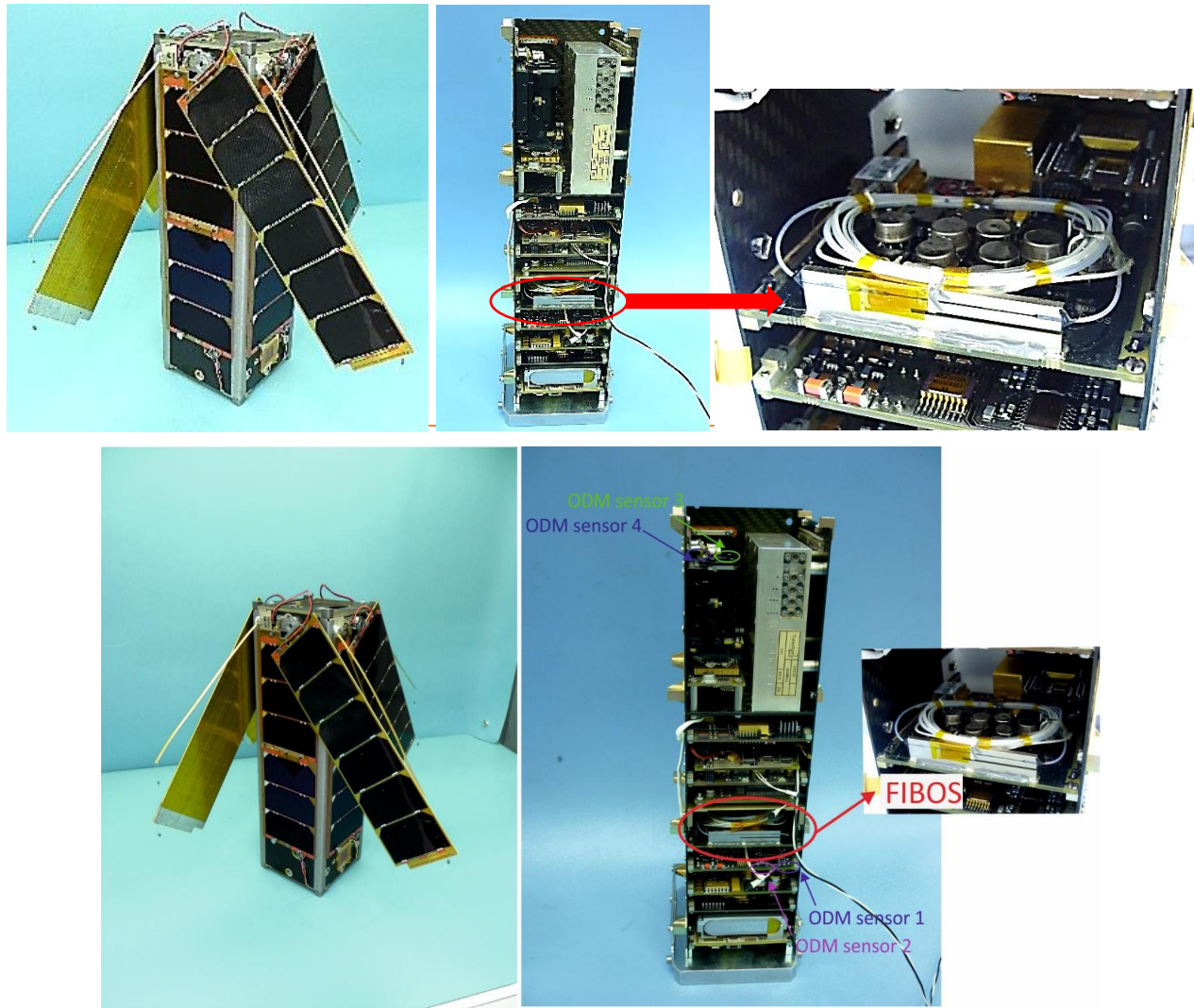

Figure 1: Left: OPTOS with antennas and solar panels; Middle: OPTOS internal structure made of composite material, view of subsystems and payloads. Right: FIBOS mounted on OPTOS structure.

The main goal of the project was to demonstrate the feasibility of using earth technologies in a small space platform such as the CubeSat standard. In this sense, OPTOS included a distributed On-Board Data Handling subsystem (OBDH) based on Floating Point Gate Arrays (FPGAs), Complex Programmable Logic Devices (CPLDs), and an optical wireless

communication system (OBCom) with a reduced Controller Area Network protocol (CAN). From the scientific point of view, OPTOS had several innovative payloads not used before in space applications including FIBOS: sensors to measure the Earth magnetic field (GMR) and the radiation environment in space (OPTOS Dose Monitoring, ODM).

The OPTOS nanosatellite was launched in November 21st (2013) as a secondary payload on a Dnepr vehicle from the Dombrovsky launch site in Russia (Yasny Cosmodrome). The launch provider was ISC Kosmotras. The primary payloads on this flight were DubaiSat-2 of EIAST (300 kg) and the STSat-3 minisatellite of KARI, Korea (~150 kg). The OPTOS ground segment was located at INTA facilities and executed the tracking, telemetry and command operations to communicate with the satellite, monitor its status and operate the payloads for their scientific mission.

The platform presented big restrictions in terms of mass, volume available and power consumption. Besides, the interrogation method was highly restricted due to low data handling capability processed by the OBDH during the mission. Consequently, the concept of a complete payload based on fiber optics sensors needed to be simple.

Regarding the size, all the OPTOS payloads had to be mounted onto a Printed Circuit Board (PCB) with maximum dimensions of 89 mm long and 79 mm wide. The maximum envelope on the top of the board was 15 mm and 3 mm in the bottom. Besides, a free area of 25 x 15 mm for an OBCom module and free extra area of 30 x 30 mm for OBDH electronics. Each payload PCB was mechanically integrated into OPTOS internal structure as an independent subsystem and linked with the satellite platform via electrical connections (see middle of Figure 1).

3. FIBOS PAYLOAD DESCRIPTION

According to platform restrictions, FIBOS weighed less than 120 g and its average power consumption when switched-on during operation mode was ~ 1.5 W.

FIBOS consists of the following units: the light source, the sensing head, the receiver and the processing unit (see Figure 2).



Figure 2. Left: FIBOS top view – FIBOS units and OBCom module. Right: FIBOS bottom view - Processing unit electronics

3.1 Light source

The light source is a monolithically integrated tunable laser (SYNTUNE, model S3500) based on a modulated grating Y-branch design with a parallel coupling of two modulated grating reflectors that allows wide tuning range. The laser, used on earth applications mostly for telecommunication purposes, has a great accuracy in wavelength emission and has no moving parts since it is tuned electronically. This laser module offered the capabilities of interest for FIBOS such as wide electronic tuning with high precision and the limitations in mass, volume and power consumption.

The laser gain current defines the output power. Besides, a semiconductor optical amplifier (SOA) is monolithically integrated in the laser chip and allows high output power. These two currents (gain and SOA) were fixed in FIBOS flight model according to the processing unit electrical design avoiding saturation of the optical detector.

The laser operation is based in the working principle of two grating reflectors and the phase area. The wavelengths emitted by the laser correspond to an aggregation of the reflections from right and left reflectors (RR and LR) when they are perfectly aligned. By tuning the current injected to both reflectors, the emitted wavelength can be shifted. By injecting a third current to what it is called the phase reflector (PR), the roundtrip phase of the cavity is changed and therefore, the wavelength shifts. Therefore, to tune the laser, it is necessary to change and combine 3 electrical currents. It is important to note that the relationship between them and the emitted wavelength is not linear and that complicates the process of calibration.

A thermistor is mounted on a carrier together with the reflectors and the SOA. A thermo-electric cooler (TEC) is used to control and maintain the temperature of the internal optical sub-assembly and this way, keep constant the wavelength emitted by the laser at a fixed temperature. In order to enable good thermal contact between the laser and the PCB, a piece of thermal gap filler (T-pli™ 200) was placed between both elements.

3.2 Sensing head

FIBOS contains two FBGs (fabricated in the so called draw tower process by FBGS Technologies): FBG1 and FBG2. The optical fiber used was a boron doped photosensitive fiber with 125 μm outside diameter and 245 μm Ormocer coated diameter. The two gratings were recorded by a frequency doubled Argon-ion laser using the same 1070.4 nm period uniform phase mask and same reflectivity and with apodization, to decrease the side-lobes.

The FBGs were mounted inside the groove of a steel type F-522 support covered by nickel that is soldered on the PCB soldering and cemented with Scotch-Weld™ 2216, recommended for spacecraft use. The mechanical mounting dimensions are 50 x 12 x 2 mm (thickness) and has 3 supports of 2 x 2 x 2 mm. The mounting has one groove with different widths that allows to fix the Teflon coating leaving free the FBG1 sensor. Besides, there is one cantilever to avoid mechanical deformations of the structure. FBG1 was mounted without strain and is only submitted to temperature changes (Bragg wavelength λ_1) and FBG2 (Bragg wavelength λ_2) was bonded in the groove along the cantilever and therefore, submitted to changes of temperature and strain of the steel but free of distortion of the PCB. FBG2 was fixed with adhesive EPO-TEK® 353ND, which meets the outgassing requirements for space applications.

Very preliminary thermal analysis of OPTOS showed a wide gradient of temperatures up to $\Delta T = 70\text{-}100$ °C during the mission depending on the location of the sensors in the satellite. The FBGs were fabricated and mounted with Bragg reflection wavelengths ~ 1.5 nm apart to cover the temperature gradient avoiding overlapping (values taken into account were the theoretical sensitivity of FBG to temperature and strain $\Delta\lambda/\Delta T \sim 8$ pm/°C and ~ 1.12 pm/ $\mu\epsilon$ and the steel thermal expansion coefficient, ~ 11 $\mu\epsilon$ /°C).

3.3 Receiver unit

The receiver unit is a standard avalanche InGaAs PIN photodiode in pigtail single-mode fiber configuration (model EPM605 from JDSU) with low back reflection and high responsivity in C-band.

All the optical fibers in FIBOS were fusion spliced (light source, sensing head and receiver unit). The splices were protected by sleeves (FINISH ADAPT-9S-SP-154) consisted of a pre-shrunk heat bonded assembly (inner material is hot-melt adhesive Ethylene Vinyl Acetate (EVA) and outer material is Polyolefin heat shrinkable tubing).

3.4 Processing unit

The processing unit contains the electrical interface with the electrical power subsystem and the Distributed OBDH Terminal (DOT); it supplies the electrical currents to tune the laser and follows the synchronization between the laser source and the receiver unit. The DOT is based on a CPLD Xilinx Cool Runner-IITM and its oscillator (2 MHz) implementation provides subsystem control of the platform and payloads. A CAN bus interface is included for receiving commands or for sending data.

The processing unit also receives the electrical signal from an integrated-circuit temperature transducer which produces an output current proportional to the absolute temperature. The purpose of this electrical sensor was to have a reference of the environmental temperature to compare it with the optical measurements performed by the FBGs. The model chosen was AD590 (Analog Devices, Inc) since it is a space qualified component. The AD590 case was bonded to the FBG mounting with Scotch-Weld™ 2216. The processing unit receives the AD590 signal and synchronizes it with the information from the thermistor laser and the PD.

One of the main parameters that defines the wavelength that emits the laser is the internal temperature. The laser temperature set point (TSP) was chosen to be close to the environmental temperature that FIBOS will encounter at the moment of its nominal operation to reduce the power consumption. The TEC is controlled by the DOT via software with a Pulse-width modulation (PWM) signal. The feedback loop to control the temperature comes from the laser thermistor. The TSP was set to 25 °C and was commanded via software and registered for each telemetry data.

The DOT provides the two injecting currents (SOA and GAIN) to fix the output optical power of the laser. In addition, it generates three independent 8-bit analog signals to the D/A converters that correspond to the electrical currents of the RR, LR and PR to tune the wavelength emitted by the laser (λ_{las}). It was necessary to create the adequate combinations of these three currents to tune the laser at the wavelengths reflected by the FBGs to operate FIBOS; this combination was called Calibration Matrix (CM).

The functional diagram of FIBOS is shown in Figure 3.

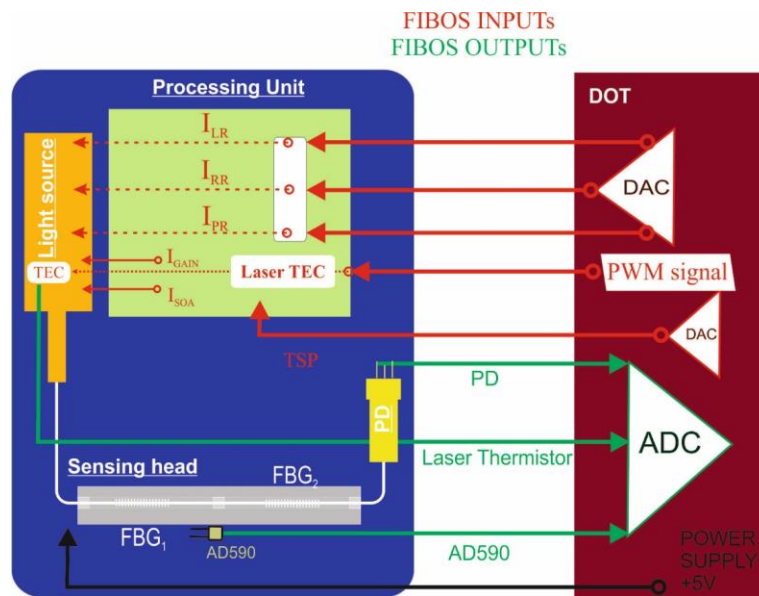

Figure 3: Functional diagram of FIBOS

4. FIBOS OPERATION

When FIBOS works in scientific mode, the operation contains two phases: the first one consists of the thermal stabilization of the laser according to the TSP; this operation was programmed to last at maximum 60 s. Measurement of the laser thermistor is taken at a rate of 1 Hz and the cycle is finished when the last 5 measurements are within the $TSP \pm 1$ °C. If the TEC is not able to stabilize the laser temperature after this period, the scientific mode is aborted.

The second phase is the nominal FIBOS operation where the DOT sends the CM to tune the laser over the spectral range of the FBGs, receives the PD signal, sends the data to the DOT and finally, the data is processed and generates the scientific telemetry. This operation takes ~ 180 s and generates heating of the PCB electronics and the laser.

The operation of FIBOS is based in a tunable laser wavelength division multiplexing (WDM) technology. The FBGs in FIBOS work in transmission to avoid the use of fiber optic couplers. The detection of λ_1 and λ_2 during the mission followed this method: the tunable laser emits one wavelength, λ_{las} (that corresponds to a row of the CM); if λ_{las} does not correspond with λ_1 nor λ_2 , the PD will receive some optical power and will transmit some voltage through the processing unit; when the λ_{las} emitted by the laser coincides with λ_1 or λ_2 all the light is ideally reflected and the PD will receive a very low level of optical power. This moment will be detected when analyzing the telemetry on ground and it will be possible to convert it into temperature. The telemetry downloaded contained information about date/time of start and end of the nominal operation, samples of the laser thermistor taken to achieve the stabilization, and a structure with the voltage data. The voltage data consists of a matrix with 256 rows and 3 columns that correspond to the values registered from the AD590 sensor, the thermistor laser and the PD. Each row of the voltage data corresponds to a λ_{las} and are recorded after each CM

row. Each voltage signal has 10 bits resolution with an analogic range between 0 and 2997.3 mV (giving a resolution of 2.93 mV).

5. EARTH CALIBRATION

In order to analyze the data during the mission, it is necessary to calibrate the payload on earth simulating the environmental conditions of the space mission during the operation mode. The aim of this calibration was to measure the response of the FBGs with temperature to compare it with the scientific data of the mission and, on the other hand, to build the CM to tune the laser during the mission.

The performance of the laser, controlled by a preliminary processing unit, was tested firstly in air and after, in vacuum conditions simulating the space environment⁴. At room conditions, when the TSP was set between 15 and 30 °C over periods of time longer than 45 min, the central wavelength emitted by the laser λ_{las} and the internal temperature of the laser remained constant within ± 8 pm and ± 0.03 °C. Other tests were performed with FIBOS Bread Board model in vacuum conditions. The wavelength emitted by the laser shifts ~ 0.66 nm to higher wavelengths in vacuum due to the change of the refractive index of the air with respect to the vacuum. It is important to note that no additional peaks appeared close to the main peak wavelength λ_{las} showing good behavior of the laser in vacuum conditions.

Subsequent tests measured the wavelength emitted by the laser in vacuum conditions when the baseplate temperature of the TVC was between -20 and 20 °C. In this test, the TSP was fixed to 12 °C⁵. These measurements were taken over periods of time longer than one hour after stabilization of the laser internal temperature. The change of emitted wavelength with temperature was 1 pm/°C when the temperature was between 5 and 15°C; the success of the stabilization of the laser gave confidence to use it for OPTOS mission. Below 5°C the spectrum of the laser was degraded due to a bad working of the TEC. These results helped to model the control of the TEC and to define the TSP during the mission taking into count the restriction of power consumption of the satellite platform. Another important parameter was to define the deviation value in the thermistor temperature from the TSP established to abort the scientific mode during the mission; this difference was set to ± 1 °C giving an error of ± 1 pm.

The CM uploaded in the mission was created during a test with the laser in vacuum conditions at 25 °C. The CM had a mean increment of the wavelength emitted by the laser of 12 ± 5 pm organized in 256 rows; each row corresponds to a specific combination of RR, LR and PR electrical currents and the CM covered a spectral range from 1537.5 to 1540.6 nm. This yields to a resolution of $\sim 1.0 \pm 0.4$ °C and $\sim 0.5 \pm 0.2$ °C for the free and the strained FBG, respectively, taking into account the sensitivity and analysis of discrete points. This value can be improved with on ground analysis based on derivatives and Gauss peak fitting.

The ground calibration tests of FBGs in vacuum were performed with the Flight Model payload taking into account the AD590 measurements as reference of the specimen, as it happens in the operation mode during the mission. This calibration inside a TVC yielded a sensitivity of $\Delta\lambda/\Delta T \sim 12.7$ pm/°C and ~ 22.3 pm/°C for FBG1 and FBG2, respectively. It was observed that the temperature of the AD590 increased ~ 4.5 °C due to heating of electronics during the CM transfer.

6. IN-ORBIT RESULTS

After OPTOS launch in November 2013 and the commissioning phase finished, the first phase of FIBOS operation consisted in evaluating the environmental temperature by comparison with measurements from other payload sensors; the temperature sensors chosen were the ODM sensors according to its location close to FIBOS. In this phase, the aim was to assure that the limits of operation of the laser in terms of temperature were not exceeded (according to provider, the temperature range for operation is between -5 to 75 °C). The temperatures measured were between 14 and 32°C approximately and therefore, subsequent operations of FIBOS could be considered safe without damaging the laser. The measurements were performed in the worst case in terms of temperature: 5 minutes before the end of sunlit phase and 10 minutes after, covering a range of 15 min of acquisition. The temperatures from the ODM sensors, the FIBOS laser thermistor and the AD590 were compared. Measurements differed a maximum of ~ 8 °C due to differences in power consumption of each payload and the location of the sensors (for example, ODM1 sensor was close to a battery; an example can be seen in Figure 4).

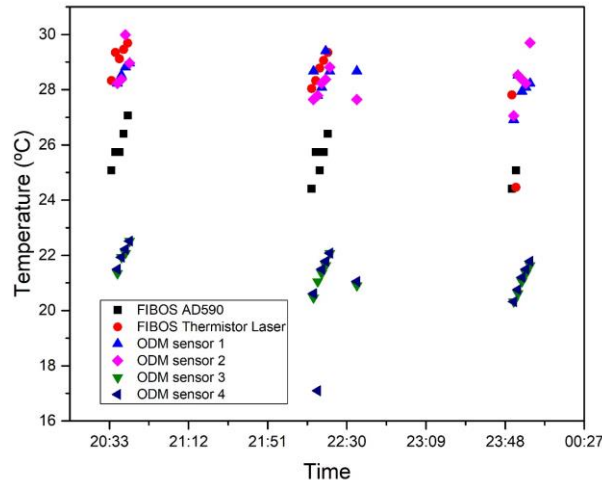

Figure 4: Temperature measured at the different moments of one orbit by ODM sensors and FIBOS sensors (AD590 and laser thermistor).

The second phase of FIBOS operation consisted in characterizing a complete orbit in terms of temperature. Since the orbit is heliosynchronous, it can be assumed that the temperature during several orbits is maintained. This operation was carried out taking data from FIBOS each 5° over a complete orbit. In this operation, FIBOS was not operated in scientific mode and the laser was switched on emitting only one wavelength to be able to extract the information of the internal temperature of the laser. After this phase, the environmental temperature of a complete orbit was characterized; it was checked that measurements in different days were equal according to predictions for this kind of orbits (see Figure 5).

The third phase consisted in finding the best location within an orbit to avoid the overheating of the laser during nominal operation of FIBOS provoking excess of power consumption by the TEC. Measurements were taken operating FIBOS in scientific mode in 3 subsequent orbits at three different orbital moments, specifically at 1000, 1300 and 1600 s after the eclipse phase. After analyzing the data received from the laser thermistor and the AD590, the best moment to operate FIBOS was set at 1600 s after the end of the eclipse phase when the environmental temperature was near 24.5 °C (see Figure 5; data of two sets of measurements). At this moment of the orbit, the environmental temperature increases and this will help the control of the TEC during FIBOS operation to maintain the laser temperature stable.

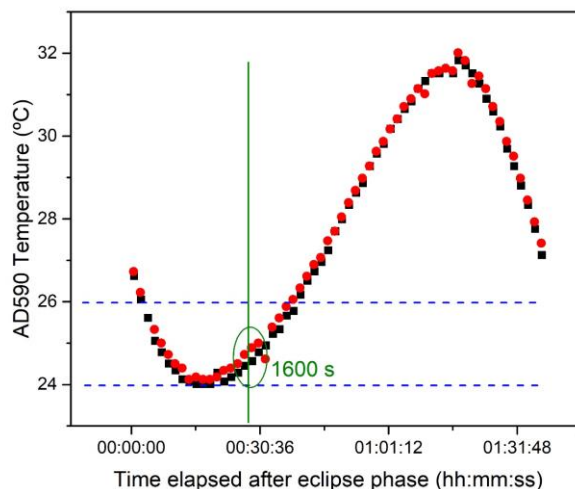

Figure 5: Extract of two temperature measurements taken from the AD590 sensor each 5° over an orbit at two different moments of the day.

The fourth phase consisted in operation of FIBOS in scientific mode to extract the temperature information and validate the use of FIBOS in space by comparing the telemetry with the on-ground calibration data.

The nominal operations of FIBOS was commanded when the environmental temperature was ~ 25 °C; some additional tests at temperatures up to 34 °C were also performed to test the limitations of the payload in terms of functionality. It was checked that even when the environmental temperature was near 34 °C, the temperature of the laser is stabilized and controlled by the TEC during the first phase of the nominal operation (thermal stabilization of the laser).

An example of the telemetry data can be seen in Figure 4. Temperature data from AD590 sensor and laser thermistor during CM upload are calculated from the voltage data. The PD voltage is represented with respect to λ_{las} according to the values measured during on-ground calibration. It is important to note that the resolution of the digital signal from the AD590 was 2.93 mV, which corresponds to 0.7 °C in terms of resolution.

The detection of the FBG minima peaks was executed on ground with the PD voltage telemetry data. The method uses a MATLAB algorithm based on derivatives to identify stationary points as local minima. The minima peaks are transformed to wavelength by identifying their position in the CM and then, converted to temperature by using the FBG sensitivity factor, $\Delta\lambda/\Delta T$ measured on ground. The telemetry analyzed when the environment was at a temperature close to the established TSP shows good results when comparing the temperature measured by the AD590 and the temperature calculated optically from the FBGs. In these cases, there is a mean absolute difference of $\sim 0.5 \pm 0.8$ °C for the free FBG and 0.5 ± 0.3 °C for the fixed FBG showing high standard deviation according to predictions. During the nominal operation it was observed that the AD590 temperature between the start and the end of the CM uploading (3 minutes long) increased a mean value of ~ 5°C due to power consumption (see up left in [Figure 6](#) ~~Figure 6~~). In the case of the thermistor laser, when the environment was at a temperature close to the TSP= 25.5 °C, the temperature of the laser remains constant within ± 0.02 °C during the CM operation assuring good working of this unit.

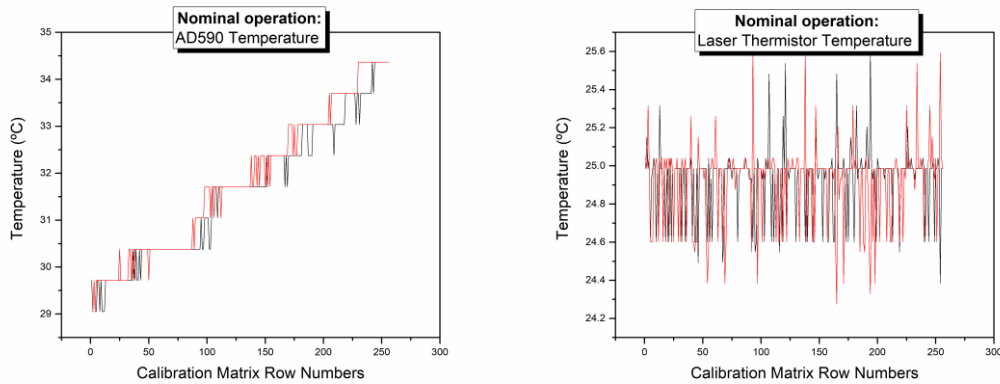

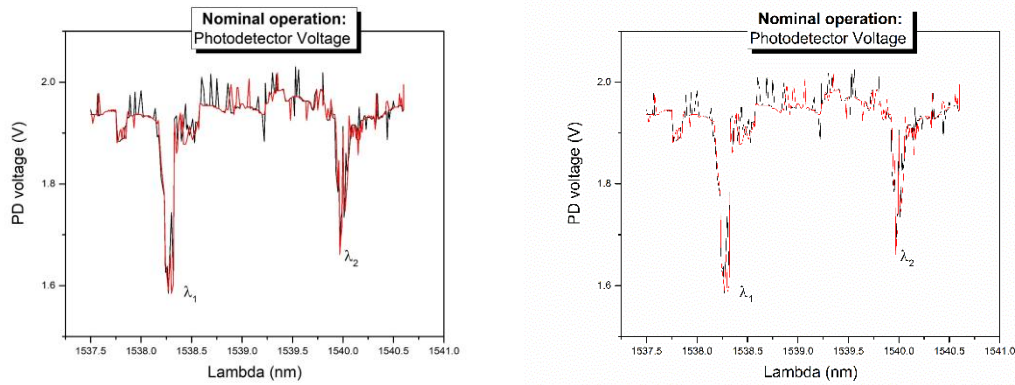
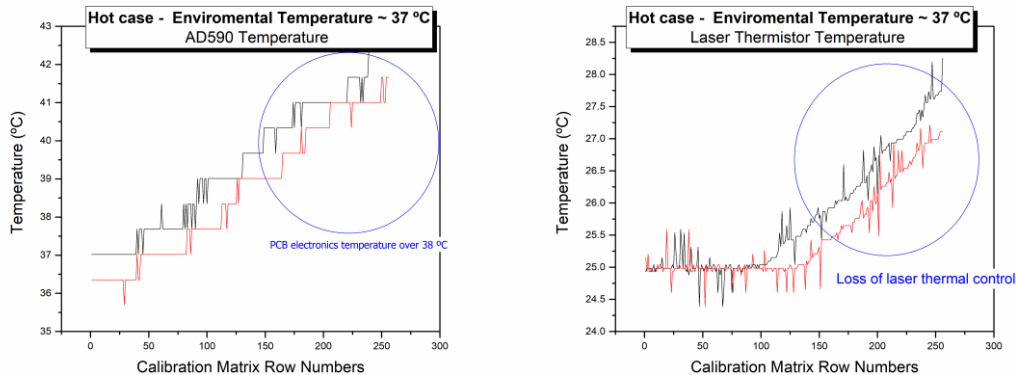

Figure 6: Raw telemetry data: AD590 temperature during CM upload (up left), laser thermistor temperature (up right) during CM upload and PD voltage with respect to λ_{las} (down). Sharp augmentation in AD590 data is due to resolution of 2.93 mV in analog conversion, equivalent to 0.7 °C.

Additional operation of FIBOS were commanded when the environmental temperature was much greater than the TSP, $T > 32^\circ\text{C}$. An example of raw data in these hot situations is shown in [Figure 7](#), where $T = 37^\circ\text{C}$ at the beginning of the nominal operation. It can be observed that the temperature measured by the AD590 increases 6 °C and the thermistor laser temperature 3.3 °C during the CM upload; this situation led occasionally to a loss of thermal control of the TEC clearly appreciated in the evolution of the laser thermistor data shown in [Figure 7](#). It is important to note that in most of the cases the TEC was capable to maintain the temperature of the laser within $\pm 1^\circ\text{C}$, which was the deviation value established for a good working in operating mode. In these situations, we can observe that the differences between data from AD590 and the FBGs increase to a mean value of $3.4^\circ\text{C} \pm 0.8^\circ\text{C}$ in the free FBG and $1.6^\circ\text{C} \pm 0.5^\circ\text{C}$ in the fixed FBG. When there is a loss of thermal control of the laser, the differences increase to 7 °C as shown in [Figure 7](#) and this shows that the calibration data stop being valid. These results show the limitations of the payload when the environmental temperature is over 32°C due to overheating of the PCB components and the limitations of the TEC. This fact could be overcome with uploads of CM for different temperatures built on-ground and with electronics with wider range of power consumption.



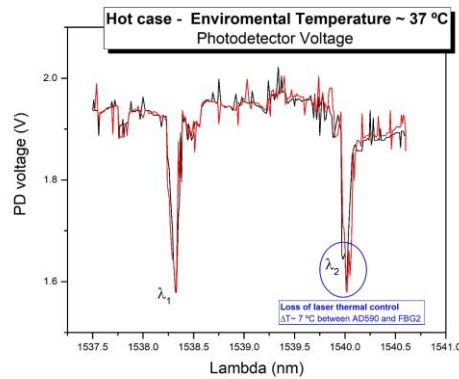

Figure 7: Raw telemetry data in hot case where $T= 37 \text{ }^\circ\text{C}$: AD590 temperature during CM upload (up left), laser thermistor temperature (up right) during CM upload and PD voltage with respect to λ_{las} (down). Note the loss of thermal control of the laser.

Another important result from the mission is the good working of the COTS element used in FIBOS. There has not been any attenuation due to radiation in the optical power transmitted by the whole system consisted of the laser, the FBGs and the PD. The PD voltage level stayed the same between the start and the end of the mission (see [Figure 8](#), data with 2 years difference and different environmental temperatures). The accumulated dose measured by ODM in 2 years was ~ 300 rad (450 rad in total of 3 years of mission).

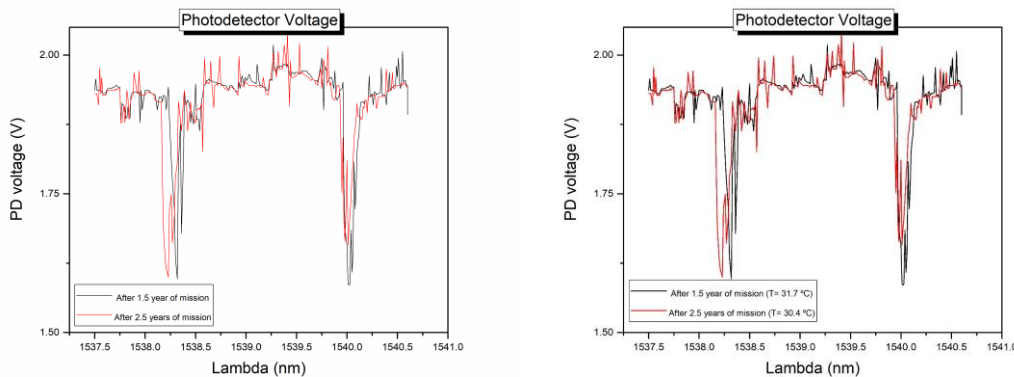

Figure 8: PD voltage data with an interval of 1 year- Black: after 1.5 years and Red - after 2.5 years after launch.

7. CONCLUSIONS

FIBOS has successfully demonstrated the capability and reliability of fiber optic sensors based of FBG in space applications. The results obtained with FIBOS, which is a payload with big restrictions in terms of mass, volume and power consumption, show optimal performance of all the commercial optical elements after three years in space environment.

Telemetry analysis shows that differences from ground calibration to the performances in space are in the order of $\sim 0.5 \pm 0.8 \text{ }^\circ\text{C}$ for the free FBG and $0.5 \pm 0.3 \text{ }^\circ\text{C}$ for the fixed FBG. The signal received from the PD during the whole mission shows no significant attenuation proving no degradation of the COTS optical elements due to space harsh environment including radiation and vacuum conditions. The commercial tunable laser used for telecommunications purposes on earth, demonstrated good performances in space conditions.

The lessons learnt from in-orbit results show the road for developments in future space missions, where more ambitious payloads are feasible, based on a variety of multiplexed sensor arrays with a more complex interrogator unit that will allow better resolution and operation in wider temperature range.

ACKNOWLEDGEMENTS

This project was totally financed with internal INTA funds. The authors would like to thank the whole OPTOS team at INTA and the group of Polytechnic University of Valencia for his collaboration at the beginning of the project.

REFERENCES

- [1] Mihailov S. J., "Fiber Bragg Grating Sensors for Harsh Environments," *Sensors*, 12(2), 1898-1918 (2012) doi:10.3390/s120201898.
- [2] Ott M. N., "Space flight applications of optical fiber; 30 years of space flight success," *Avionics, Fiber-Optics and Photonics Technology Conference*, 2010 IEEE, 3-4 (2010); doi: 10.1109/AVFOP.2010.5637515
- [3] Mckenzie I., Karafolas N., "Fiber optic sensing in space structures: the experience of the European Space Agency," *Proc. SPIE 5855*, 262-269 (2005); doi: 10.1117/12.623988.
- [4] Heredero R. L., Frovel M., Laguna H., Belenguer-Dávila T., "Calibration of fiber Bragg gratings for optical sensing (FIBOS) for an aerospace application, *Proc. SPIE 7293*, Smart Sensor Phenomena, Technology, Networks, and Systems, 729302 (2009).
- [5] Heredero R. L., Frovel M., Laguna H., Anderson A., Garranzo D., Belenguer-Dávila T., "Fiber Bragg gratings for optical sensing (FIBOS) for an aerospace application," *Proc. SPIE 7653*, Fourth European Workshop on Optical Fibre Sensors, 76533O (2010).