

# Optical Engineering

OpticalEngineering.SPIEDigitalLibrary.org

## **Peak-to-average power ratio mitigation and adaptive bit assignment in single-carrier frequency division multiplexing access via hierarchical modulation**

Lijia Zhang  
Bo Liu  
Xiangjun Xin  
Yongjun Wang

# Peak-to-average power ratio mitigation and adaptive bit assignment in single-carrier frequency division multiplexing access via hierarchical modulation

Lijia Zhang,<sup>a,b</sup> Bo Liu,<sup>a,b,\*</sup> Xiangjun Xin,<sup>a,b</sup> and Yongjun Wang<sup>b</sup>

<sup>a</sup>Beijing University of Posts and Telecommunications, State Key Laboratory of Information Photonics and Optical Communications, No. 10 Xitucheng Road, Beijing 100876, China

<sup>b</sup>Beijing University of Posts and Telecommunications, School of Electronic Engineering, No. 10 Xitucheng Road, Beijing 100876, China

**Abstract.** A hierarchical modulation with multilevels is proposed for an optical single-carrier frequency division multiplexing access (SC-FDMA) system. It can mitigate the nonlinearity by reducing the peak-to-average power ratio (PAPR) of the SC-FDM signal. According to different optical signal-to-noise ratio requirements, the adaptive bit allocation can be implemented on different levels during hierarchical modulation. In the experiment, the PAPR of the hierarchical-modulated SC-FDM signal outperforms the conventional SC-FDM signal by 0.7 dB. Signals with 4- and 6-bit hierarchical modulation are successfully demodulated by the optical network unit with power penalties less than 0.2 and 0.45 dB, respectively. © The Authors. Published by SPIE under a Creative Commons Attribution 3.0 Unported License. Distribution or reproduction of this work in whole or in part requires full attribution of the original publication, including its DOI. [DOI: [10.1117/1.OE.53.11.116115](https://doi.org/10.1117/1.OE.53.11.116115)]

Keywords: single-carrier frequency division multiplexing access; hierarchical modulation; adaptive bit assignment.

Paper 141334 received Aug. 25, 2014; accepted for publication Oct. 30, 2014; published online Nov. 25, 2014.

## 1 Introduction

Over the last years, the explosion of Internet and broadband services has led to exponential traffic growth in optical access networks. Due to the diversity of services and different bandwidth requirements, the future optical access network is anticipated to offer spectrally efficient and adaptive resource allocation with agile granularities.<sup>1-4</sup> Digital signal processing (DSP) technology has played a vital role in the future of flexible access networks. It can not only realize flexible networking without human intervention but can also provide advanced computation to combat the signal distortions such as fiber dispersion and nonlinearity.<sup>5,6</sup> Optical single-carrier frequency division multiplexing access (SC-FDMA) is a prominent example of a DSP-based optical access network. It is first considered in the 3G long-term evolution of the 3GPP standard<sup>7</sup> and has a lower peak-to-average power ratio (PAPR) with a similar throughput performance compared with an optical frequency division multiplexing access.

For an SC-FDMA system, high-order modulation formats can be employed to improve the spectrum efficiency (SE). Generally, quadrature amplitude modulation (QAM) is adopted to increase the SE of the SC-FDM signal. However, it is a kind of fixed mapping format where all the services or users adopt the same bit assignment. Hierarchical modulation has recently attracted much attention both in optical and wireless communication systems, and it can improve the power margin of the network.<sup>8,9</sup> In addition, we have found it can separate different services into different levels of constellation according to the quality of service or optical signal-to-noise ratio condition of the optical network unit (ONU). In addition, the PAPR of the SC-FDMA signal can be further reduced due to the unequal Euclidean

distances of the constellation in hierarchical modulation, which can mitigate the nonlinearity during optical signal modulation and fiber transmission.

In this paper, a multilevel hierarchical modulation is proposed to mitigate the PAPR and realize adaptive bit assignment in an SC-FDMA system. It enables unequal bit assignment through the different levels of hierarchical modulation. Furthermore, the Euclidean distance on each level can be adjusted in order to increase the PAPR tolerance. In the experiment, an adaptive bit assigned SC-FDMA system with hierarchical modulation is successfully demonstrated over a 25-km single-mode fiber (SMF). The performance comparison between QAM and hierarchical modulation is also studied in the system.

## 2 Principle

The schematic diagram of the hierarchical-modulated SC-FDM signal is illustrated in Fig. 1. At the transmitter, the data stream is first divided into several subdata streams and each subdata stream is modulated onto one level of hierarchical modulation. Different levels contain different bit numbers. Then an  $M$ -point discrete Fourier transform (DFT) is applied on the hierarchical-modulated parallel symbols to create the frequency domain signal. The inverse fast Fourier transform is employed to produce the time domain SC-FDM signal. At the receiver, the data can be obtained using the reverse operation.

In this letter, we adopt 4- and 6-bit hierarchical modulations for demonstration. Table 1 illustrates the mapping principle of the hierarchical modulation with multilevels. There we define the Euclidean distances of different levels as  $d_n$  ( $n = 1, 2, 3$ ) and the ratio between Euclidean distances as  $r_n = d_{n+1}/d_n$ , where  $n$  is the  $n$ 'th hierarchical level. In Table 1,  $b_i$  represents the input binary bit stream. The distance ratio of  $r_n$  can be adjustable according to the channel condition. When  $r_n$  becomes larger, the PAPR of SC-FDM

\*Address all correspondence to: Bo Liu, E-mail: [dabaobupt@gmail.com](mailto:dabaobupt@gmail.com)

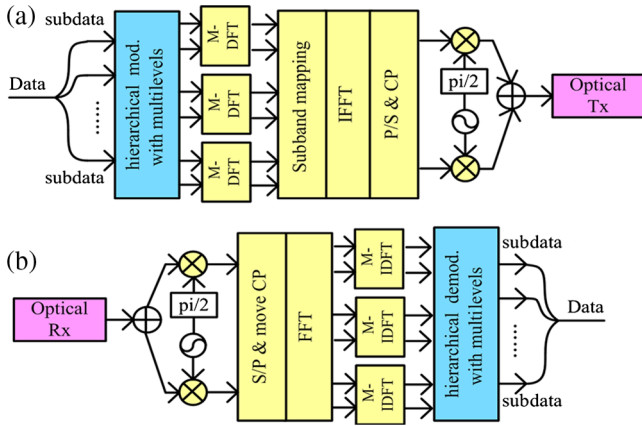
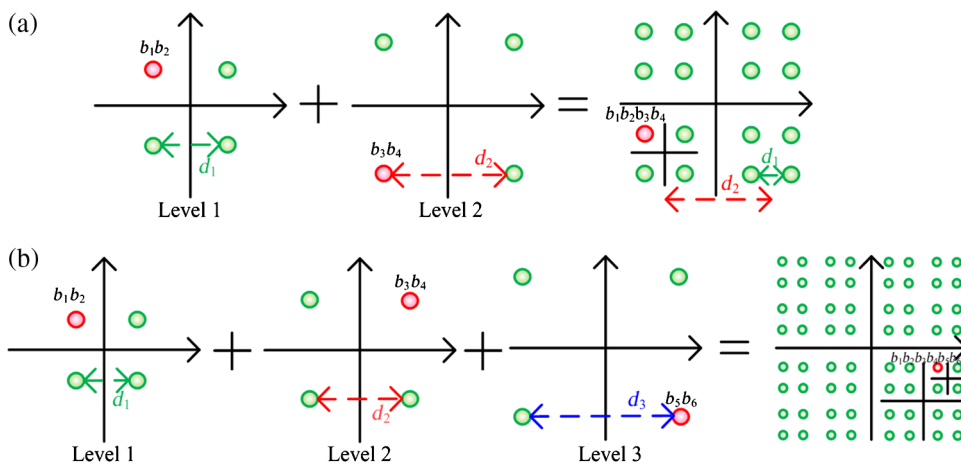

**Fig. 1** The schematic diagram of hierarchical-modulated single-carrier frequency division multiplexing (SC-FDM) signal: (a) transmitter; (b) receiver.

**Table 1** Mapping principle for hierarchical modulation.

Bit number	Level 1		Level 2		Level 3		
	$d_1$	bits	$d_2$	bits	$d_3$	bits	
4	$d_1$	$b_1b_2$	$r_1d_1$	$b_3b_4$	—	—	
Case A	$d_1$	$b_1b_2$	$r_1d_1$	$b_3b_4b_5b_6$	—	—	
6	Case B	$d_1$	$b_1b_2b_3b_4$	$r_1d_1$	$b_5b_6$	—	—
Case C	$d_1$	$b_1b_2$	$r_1d_1$	$b_3b_4$	$r_1r_2d_1$	$b_5b_6$	

signal would be better; however, the received sensitivity would be more critical. Therefore, there must be a tradeoff between the PAPR and the received sensitivity. For a 4-bit hierarchical modulation, there are a total of two levels and each level has 2 bits. A 6-bit hierarchical modulation can be divided into two cases: two levels and three levels. As the bit numbers increase, there would be more levels. Figures 2(a) and 2(b) show examples of 4- and 6-bit hierarchical modulations, respectively. With hierarchical modulation, the service or user can choose one or more levels, which enables an adaptive bit assignment for ONU.



**Fig. 2** The examples of hierarchical modulation with (a) 4 bits of two levels; (b) 6 bits of three levels.

### 3 Experiment and Results

Figure 3 illustrates the experimental setup for a hierarchical-modulated SC-FDMA system, where we adopt two ONUs and intensity modulated/direct detection for demonstration. A commercial CW laser at 1551.72 nm and a single driven Mach-Zender modulator (MZM) are employed as the optical transmitter. The hierarchical-modulated SC-FDM signal is produced offline by MATLAB and the modulation procedure has been illustrated in Fig. 1. In the experiment, the 4- and 6-bit hierarchical modulations both have two levels. We assign level 1 for ONU-1 and level 2 for ONU-2. We adopt a 256-point DFT with a two times up-sampling. The cyclic prefix length is 1/16 of the symbol length. An arbitrary waveform generator (AWG7122B) acts as the D/A converter, and has a sample rate of 10 Gs/s with 8-bit resolution. The electrical spectra before and after modulation are shown as insets (i) and (ii) in Fig. 3, where the bandwidth is about 2.8 GHz and the central frequency is 2 GHz. The total rates are 10.5 and 15.75 Gb/s for 4- and 6-bit hierarchical modulation, respectively. The MZM is driven by the generated signal at 1.7 V with a half-voltage of 3.5 V. The optical spectrum is also shown as inset (iii) in Fig. 3. The optical SC-FDM signal is amplified to 4 dBm before being launched in the 25-km SMF. In the optical access network, the typical fiber length is about 25 km. Therefore, we choose 25-km SMF in the experiment for demonstration.

After transmission, a 1:2 power splitter is employed to route the signal to the two ONUs. At the ONU, an optical filter is adopted to suppress the amplified spontaneous emission (ASE) noise. During the experiment, the ASE noise does not have a large impact on the signal. However, in order to suppress the burst broadband noise and ensure the stability of the measurement, we reserve the optical filter at the receiver. We use a variable optical attenuator to change the received optical power during measurement. A photodiode with a 3-dB bandwidth of 10 GHz is employed to realize optical to electrical conversion. The detected SC-FDM signal is sampled by a 20-Gs/s real-time digital oscilloscope for offline processing.

First, we measure the PAPR for the optical SC-FDM signal with two levels under different ratios. Figure 4 shows the measured complementary cumulative distribution function (CCDF) of the signal with 4-bit hierarchical modulation where 5000 symbols are measured. When the ratio  $r_1$  varies

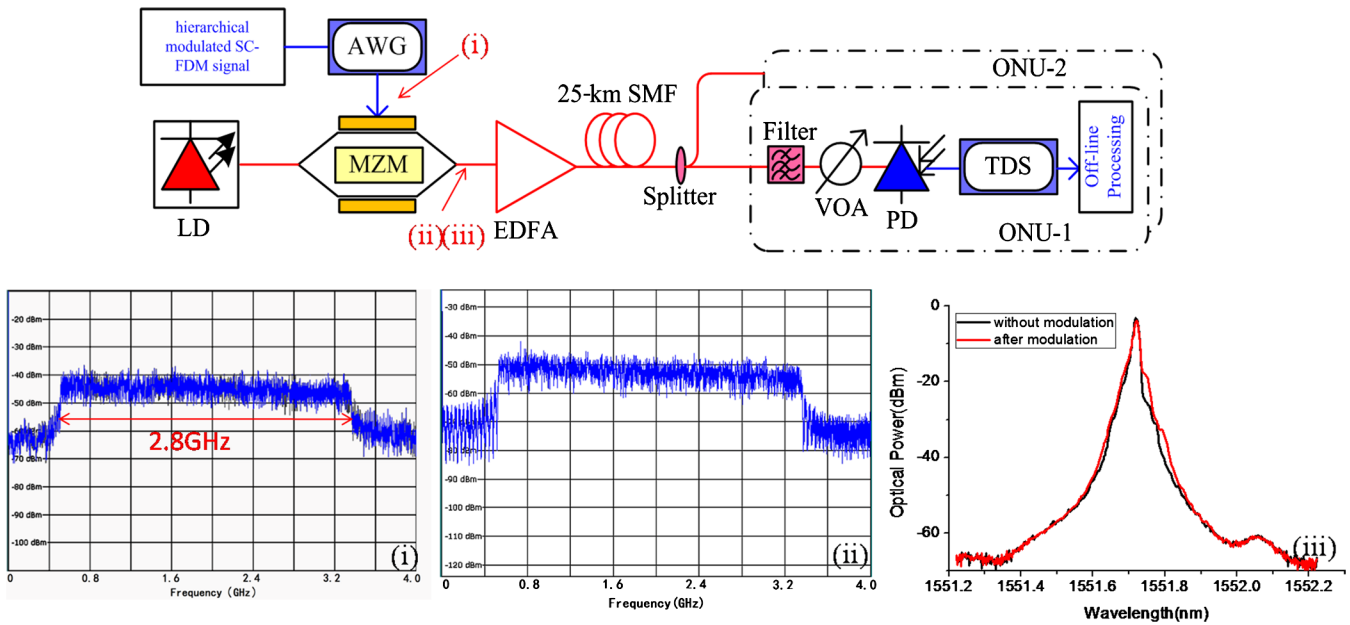

**Fig. 3** The experimental setup for the SC-FDMA system with hierarchical modulation (AWG: arbitrary waveform generator; MZM: Mach-Zehnder modulator; EDFA: Er-doped fiber amplifier; VOA: variable optical attenuator; PD: photodiode; TDS: real-time digital oscilloscope).

from 2 to 4, the PAPRs at CCDF of  $1 \times 10^{-3}$  are 9, 8.5, and 8.3 dB, respectively. For  $r_1 = 2$ , the Euclidean distance of the hierarchical modulation is the same as conventional 16QAM modulation, which means that the PAPR can be improved by 0.7 dB with hierarchical modulation.

Figure 5 illustrates the PAPR at a CCDF of  $10^{-3}$  and a bit error ratio (BER) of level 1 for a 4-bit hierarchical-modulated optical SC-FDM signal with different values of  $r_1$ , where the launched optical power is set to constant of 4 dBm. As  $r_1$  increases, the PAPR is reduced from 9 to 7.9 dB while the BER of level 1 deteriorates due to the reduced Euclidean distance. The constellations are also shown in Fig. 5 and they directly illustrate the reason for BER deterioration. Considering the above, we choose  $r_1 \leq 4$  in our following investigation.

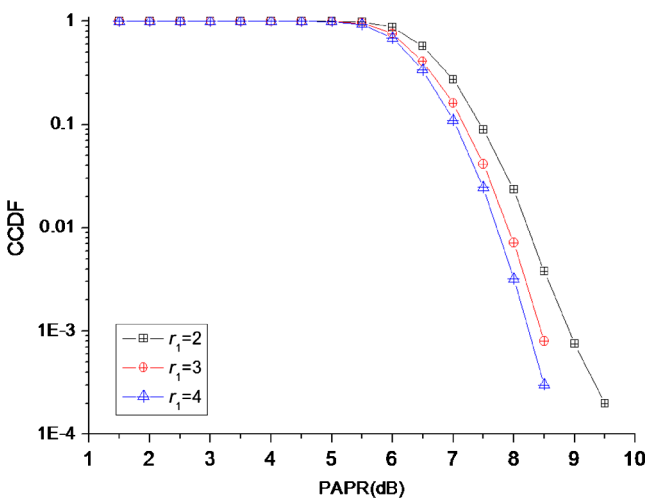

**Fig. 4** The complementary cumulative distribution function (CCDF) of optical SC-FDM signal with 4-bit hierarchical modulation.

Next, we investigate the performance of different hierarchical-modulated SC-FDM access signals at the ONU. Both the back-to-back (b2b) and transmission cases are measured during the experiment. The b2b case means that there is no fiber transmission between the transmitter and the receiver. Figure 6 shows the measured BER curves for a 4-bit hierarchical-modulated SC-FDM signal with a different  $r_1$ . The power penalties before and after transmission for both the levels are less than 0.2 dB. When  $r_1 = 3$ , the received sensitivities at BER of  $10^{-3}$  are  $-17.6$  and  $-22.8$  dBm for level 1 and level 2, respectively. When  $r_1 = 4$ , the sensitivity difference between them becomes larger by 2 dB. For a normal 16QAM SC-FDM signal, the corresponding received sensitivity is about  $-20.2$  dBm, which is same as for  $r_1 = 2$ . If the channel condition is good, the ONU can choose either or

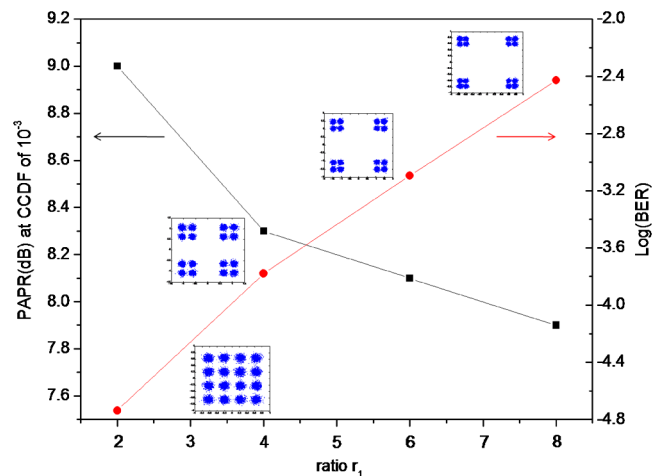

**Fig. 5** The measured peak-to-average power ratio (PAPR) and bit error ratio (BER) of level 1 for 4-bit hierarchical-modulated optical SC-FDM signal with different  $r_1$  (received optical power =  $-14$  dBm, b2b).

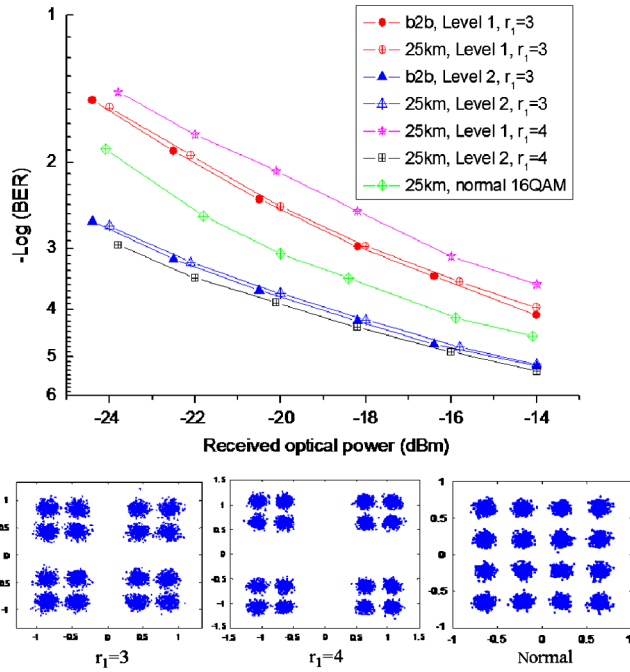

Fig. 6 The measured BER curves for 4-bit hierarchical-modulated SC-FDM signal with different  $r_1$ .

both levels, which enables 2 bits per symbol or 4 bits per symbol. Figure 7 illustrates the BER performance of a 6-bit hierarchical-modulated SC-FDM signal. Compared with Fig. 6, the power penalty increases about 0.25 dB, which is due to the shorter Euclidean distance. For both the 4- and 6-bit hierarchical-modulated SC-FDM signals, the power penalty of level 2 is less than that of level 1 under the same channel noise. In Fig. 7, the received

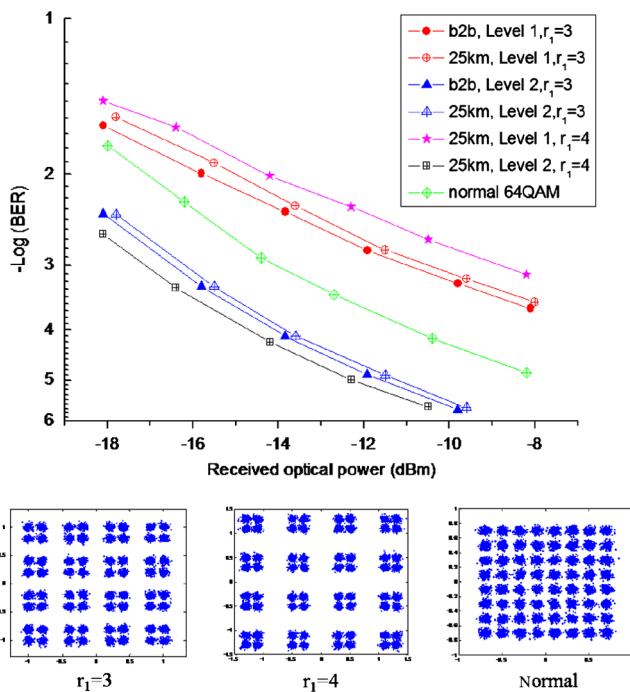

Fig. 7 The measured BER curves for 6-bit hierarchical-modulated SC-FDM signal with different  $r_1$ .

sensitivities at BER of  $10^{-3}$  are  $-10.5$  and  $-16.2$  dBm for level 1 and level 2 when  $r_1 = 3$ . The ONU can choose a suitable level and distance ratio according to the channel condition or service requirement.

### 4 Conclusion

We have proposed a multilevel hierarchical-modulated SC-FDMA system, which could mitigate the PAPR as well as realize adaptive bit assignment. In the experiment, the PAPR is improved by 0.7 dB after a 4-bit hierarchical modulation with a distance ratio of 4. The power penalties are about 0.2 and 0.45 dB for level 1 of the 4- and 6-bit hierarchical-modulated SC-FDM signals, respectively, and the penalty improves for level 2. The proposed adaptive bit allocation by hierarchical modulation provides a practical alternative to conventional QAM in future flexible access networks.

### Acknowledgments

The financial supports from National High Technology 863 Program of China (No. 2013AA013403/2012AA011304), National NSFC (No. 61307086/61205066/61475024), Beijing Nova Program (No. Z141101001814048), Beijing Excellent PhD. Thesis Guidance Foundation (No. 20121001302) and the Universities PhD Special Research Funds (No. 20120005120007) are gratefully acknowledged. The project is also supported by the Fundamental Research Funds for the Central Universities (grant no. 2014RC0203) and Fund of State Key Laboratory of IPOC (BUPT).

### References

1. N. Cvijetic, "OFDM for next-generation optical access networks," *J. Lightwave Technol.* **30**(4), 384–398 (2012).
2. N. Sotiriopoulos, A. M. J. Koonen, and H. Waardt, "Next-generation TDM-PON based on multilevel differential modulation," *Photonics Technol. Lett.* **25**(5), 418–421 (2013).
3. G. Wu et al., "Real-time Ethernet based on passive optical networks," *Opt. Eng.* **52**(2), 025007 (2013).
4. Q. Han, W. Li, and M. Yang, "An optical waveform pre-distortion method based on time-domain fractional Fourier transformation," *Opt. Commun.* **284**(2), 660–664 (2011).
5. X.Q. Jin et al., "First real-time experimental demonstrations of 11.25Gb/s optical OFDMA PONs with adaptive dynamic bandwidth allocation," *Opt. Express* **19**, 20557–20570 (2011).
6. L. Tao et al., "Spectrally efficient localized carrier distribution scheme for multiple-user DFT-S OFDM RoF-PON wireless access systems," *Opt. Express* **20**, 29665–29672 (2012).
7. 3rd Generation Partnership Project, Technical Specification Group Radio Access Network, Base Station (BS) radio transmission and reception (Release 8), 3GPP TS 36.104 V 8.2.0 (2008-05), Std., May 2008, retrieved (2008).
8. N. Iiyama et al., "Co-existent downstream scheme between OOK and QAM signals in an optical access network using software-defined technology," in *Proc. OFC'12*, USA, paper.JTh2A.53 (2012).
9. S. J. Lee et al., "Analytical performance evaluation of hierarchical 16 QAM for multicast/broadcast transmission," *IEEE Commun. Lett.* **16**(10), 1536–1539 (2012).

**Lijia Zhang** is an associate professor at the Beijing University of Posts and Telecommunications (BUPT) and a member of the State Key Laboratory of Information Photonics and Optical Communications in BUPT. She received her BS and PhD degrees from the School of Electric and Engineering, BUPT, Beijing, China, in 2007 and 2011. Her current research interests include optical communication and all-optical network.

**Bo Liu** is a lecturer at BUPT and a member of the State Key Laboratory of Information Photonics and Optical Communications at BUPT. He received his PhD degree from BUPT in 2013. His research interests include broadband optical communications and optical signal processing.

**Xiangjun Xin** received his PhD degree from BUPT, China, in 2004. Currently, he is a professor of the School of Electric Engineering and a member of the State Key Laboratory of Information Photonics and Optical Communications at BUPT. His main research interests focus on optical transmission technologies, optical sensors, and all-optical networks. Within this area, he has published more than 80 journal and conference papers.

**Yongjun Wang** received his PhD degree from Beijing Jiaotong University in 2008. He is an associate professor of the School of Electric Engineering. His research interests include fiber sensors and optical signal processing.